

*Freedom
to choose*



ISSUE 7

Catalogue



Company Ethos

What we do

- We provide high quality Haddenham branded products and services
- Our customers are healthcare professionals and their patients
- We supply direct to the market and in partnership with specialist distributors
- We have companies in the UK and Australia, and we invest in partnerships to distribute Haddenham brands in Europe and Asia

Our focus

- Lymphoedema, Chronic Oedema and Lipoedema
- Vascular, Wound Care and Breast Care

How we do it

- We have passion for the markets we serve, and are innovative and responsive
- We form close long-term partnerships with our customers and suppliers
- We stand out by being 'problem solvers' and provide first class service
- We continually listen, learn and improve

Our values and beliefs

- We work to improve the quality of life of our customers and employees
- Our central values are caring, sharing and learning
- We donate ten percent of our annual retained earnings to charity and good causes

Our objectives

- To be leaders in our focus markets
- To create long term value from our products and services
- To be knowledge led and to make a positive contribution to society
- To create fair profits to invest in a bright future



Behind the cover

The design for the Issue 7 'Freedom to Choose' Catalogue features a brightly coloured origami butterfly. Origami, the ancient art of paper folding, is fun and accessible for all, from beginners to the experienced. For many, the practice is enjoyed for its calming quality. This process of transforming simple squares of paper into beautiful forms can be likened to choosing appropriate compression which also requires care and attention to details. The goal is to arrive at the most efficient and elegant means of achieving a desired outcome.

Butterflies are a familiar symbol of life, resilience, and triumph. From small and humble caterpillars, these insects transform themselves into glorious, winged creatures. Observing them in flight is fascinating; some soar slowly, with only a few flaps of their wings, while others seem to dart in every direction at once. This could be seen as a metaphor for the unique treatment journey each patient in your care is traveling.

So, with freedom to choose and the desire to bring about positive change, know we are with you always, sitting softly on your shoulder. Haddenham Healthcare can be your source of inspiration and motivation to help transform lives. We can work together on the path to achieve clinical effectiveness.

Lower Limb

Lower limb garments in a variety of styles and compression, with wide ranging sizes and options.

13 ▶

Upper Limb

Upper limb garments in a variety of styles and compression, with wide ranging sizes and options.

53 ▶

Easywrap

easywrap is a low-profile compression wrap system that can be worn comfortably under most everyday clothing and footwear.

77 ▶

Comfiwave

Comfiwave features a high elastic knit with 100% cotton in skin contact. Suitable for day and night compression.

97 ▶

Midline

Garments for head, neck, breast, genital and torso oedema.

113 ▶

Essentials

Kinesiology tape, skin care products and garment donning aids.

133 ▶

Lymphtech

The latest technology in lymphoedema monitoring and assessment.

147 ▶

Terms and Conditions

Accounts/Purchase Orders:

Order processing: To avoid delays and additional cost, please consider your choices carefully. Incomplete details will delay despatch.

Despatch: Stock orders within 1-2 business days, MTO and Custom Made garments within 10-12 business days.

Time frames are reliant on receiving complete order details.

Settlement: 30 days from date of invoice. Accounts payable monthly.

Client to Pay Orders:

Order processing: To avoid delays and additional cost, please consider your choices carefully. Incomplete details will delay despatch.

Settlement is required prior to:

- Despatch of Stock items;
- Manufacture of Made to Order (MTO) and Custom Made garments

Despatch: Stock orders within 1-2 business days, MTO and Custom Made garments within 10-12 business days.

Time frames are from the date payment is cleared and reliant on receiving complete order details.

Delivery and Handling: \$18.00 plus GST. A courier can be used at the customer request with additional charge.

Orders of Stock and non-stock products will be sent together once the non-stock items have arrived. Additional delivery charge could apply if you request for your order delivery to be split.

Haddenham Healthcare Ltd cannot be held responsible for a courier or mail service failure to deliver at the specified time.

Prices: All prices listed are in Australian dollars and are subject to change without notice. GST is indicated on relevant products.

Returns: Contact us within 60 days from the date the order is despatched if you need to arrange a return. Returned goods must be in a saleable condition. Under normal circumstances returned goods will be exchanged.

Non-Delivery: Notify us in writing within 21 days of despatch notification.

Warranty: Products are guaranteed against defects in material and manufacture. Specific warranty terms vary per product. Please consult each individual product's 'Instructions for Use' for details.

Liability: Responsibility for the selection and application of products rests with the professional staff treating the patient.

Privacy: Haddenham Healthcare's privacy policy can be viewed at www.hadhealth.com/privacy-policy

Product Colours: All product colours are depicted as accurately as the printing process allows.

Contraindication to compression

Absolute Contraindication: 1. Advanced peripheral arterial occlusive disease 2. Decompensated heart disease 3. Septic phlebitis and Phlegmasia cerulea dolens (swollen blue limb) 4. Diabetic patients with lack of or reduced sensation in lower limb or foot 5. Supportive dermatoses, intolerance of fabric 6. Sensory disturbances of the limb, advanced peripheral neuropathy 7. Superior vena cava obstruction 8. Axillary vein thrombosis 9. Acute cellulitis

Relative Contraindications: 1. Brachial plexus neuropathy 2. Rheumatoid arthritis 3. Diabetes (peripheral neuropathy) 4. Advanced cancer to the root of the limb 5. Primary chronic arthritis 6. Intolerance to fabric

Additional contraindications apply to particular garments. Always consult product instructions prior to use. Haddenham Healthcare Ltd assumes no liability as a result of any contraindicated use of garments.

Registered Trademarks

HADDENHAM, HADHEALTH, EASYWRAP, COMFIWAVE and STRIDE are registered trademarks of Haddenham Healthcare Ltd, UK; PulsePress is a registered trademark of MJS Healthcare Ltd; Naqi is a registered trademark of Naqi International Ltd, Belgium; DELFIN and DELFIN LYMPHSCANNER are registered trademarks of Delfin Technologies Oy.

“

“Working together to achieve clinical effectiveness”



Choose how you order

Haddenham Healthcare offers a wide range of fabrics and garment styles for your clients with options that are held in **STOCK** or uniquely **MADE TO ORDER** as well as **CUSTOM MADE** when required.

STOCK

Throughout the catalogue, items available in **STOCK** are indicated in **PINK**.

Haddenham Healthcare Australia holds **STOCK** of many products ready for same day despatch when the order is received via an account or paid for by 1pm (Melbourne time).

MADE TO ORDER

Throughout the catalogue, items available as **MADE TO ORDER (MTO)** are indicated in **GREEN**.

Haddenham Healthcare will make an individual garment to order allowing you to prescribe all aspects of the garment to suit your client without the need for them to be custom made.

The combinations are endless and will accommodate a wide range of sizes both circumferentially and in length as well as fabric options, colours and class of compression.

The catalogue will guide you through step by step to create the prescription successfully.

CUSTOM MADE

Throughout the catalogue, items available as **CUSTOM MADE** are indicated in **PURPLE**.

Haddenham Healthcare offer a Custom Made garment manufacturing service. These are fully bespoke garments offering the widest choice of style, fabric, special options and of course will be made to your client's specific measurements.

Custom Made Garment Orders

To order **CUSTOM MADE** garments, you will need to complete a **Standard Order Form** and the relevant Custom Made order form, then submit your order by email to sales@hadhealth.com.au or fax 03 9544 5512.

Ordering options

Place your order using the required order forms or via our online order portal.

Order Forms

Use the **Standard Order Form** to place your order. You can use the MTO and Custom Made forms to logically guide your garment prescription. Please note there are order forms for specific products such as Easywrap and Eto Grace.

You can choose:

- Request order form tear-off pads via sales@hadhealth.com.au
- Photocopy the order forms from the **Order Form Templates Book**.
- Download all forms at www.hadhealth.com.au/forms

Send your completed forms to:
sales@hadhealth.com.au
fax: 03 9544 5512

Haddenham Online Order Portal

The Haddenham Online Order Portal is designed for therapists as an effective way to browse our extensive range of products, place orders and request quotes.

Communication is easy and efficient using this convenient online system.

Contact us to help create your account.

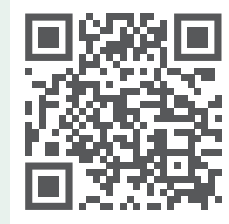

All forms available at
www.hadhealth.com.au/forms

Need help with your order?

Our customer service team are here to help.
Phone 03 9544 5515.

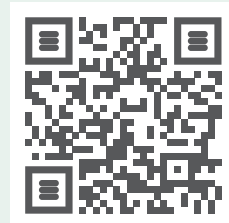

Order online at
www.hadhealth.com.au/portal

Freedom to choose

With Haddenham Healthcare, you have the choice of management options to help improve the quality of life for clients with lymphoedema, lipoedema and chronic oedema. At all stages of treatment planning, we support you to combine your clinical knowledge, skills and experience

together with your client assessment, treatment goals, understanding of our product range and our ordering options to choose products that meet a need and provide a solution for your client.

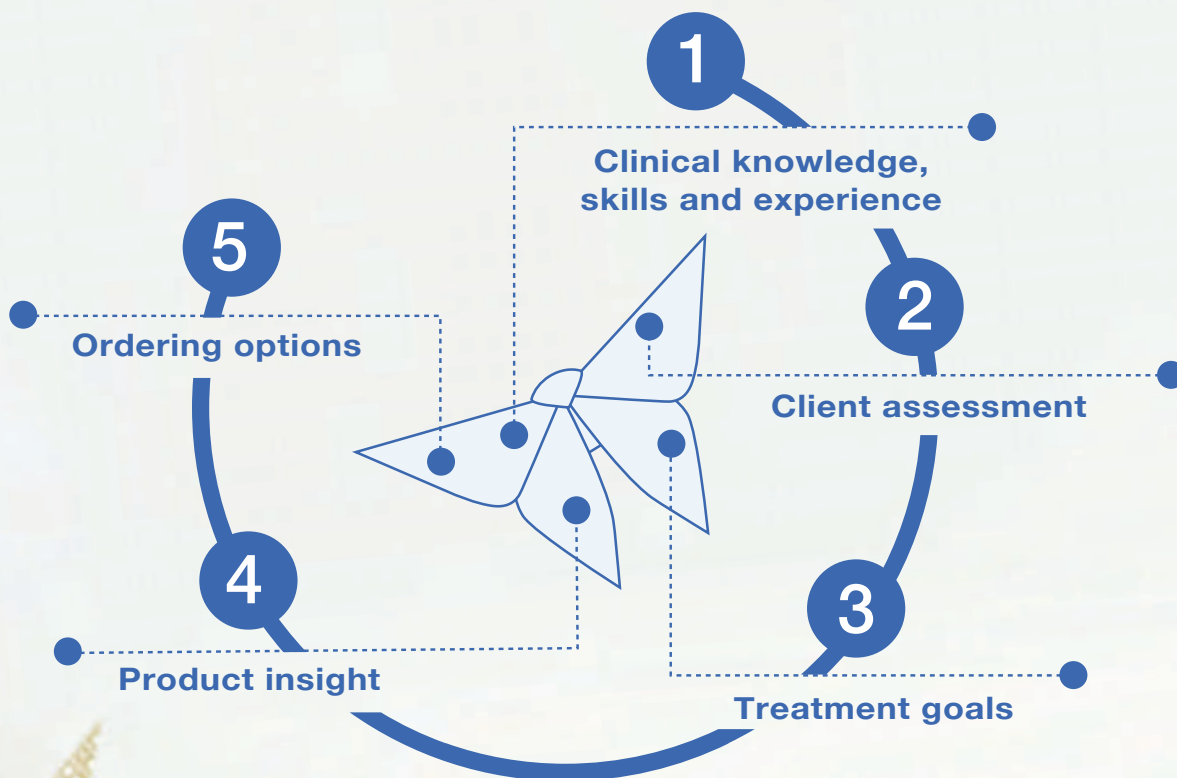

1. Clinical knowledge, skills and experience

Draw on your experience as a therapist to improve your awareness of clients' specific situations and challenges.

2. Client assessment

Conduct objective and subjective client assessment to guide your treatment planning.

3. Treatment goals

Set goals that are specific, realistic and tailored to the needs of the client.

4. Product insight

Build your awareness of Haddenham products and consider their features, benefits, price and suitability.

Product Insight provides a guide when choosing a suitable compression option to meet your treatment goals. By identifying the unique features and benefits of each compression series from the Haddenham Healthcare range, you can make informed choices that help to improve the situation for your clients. Look for this information within each series.

5. Ordering options

Recognise the various ways to order products and the possibilities this provides to best support your client.

Compression options

Haddenham Healthcare have a wide range of options designed to offer highly effective, therapeutic compression for the management of oedema and long-term, chronic swelling.

The extensive range includes circular knit, flat knit, cut and sew, whole-garment knitted garments and adjustable wraps in a variety of compression levels.

1. Adjustable wrapping devices

Haddenham Healthcare's Easywrap garments consist of overlapping, single-layer textile bands that are worn over a protective liner. The bands are secured by grip tabs that are easy to attach and are engineered to be conforming and low profile.

2. Flat knit compression garments

Flat knit garments are knitted in flat sheets that are easily customisable to any shape. These flat sheets are then usually sewn together, resulting in a seam.

3. Circular knit compression garments

Circular-knit compression stockings are knitted on a cylinder and have no seam, producing an even distribution of dosage along the garment.

4. Whole-garment knitting technology

Comfiwave products are knitted in three dimensions without seams. This enables the garment to be made stiffer or softer at specific areas and shaped to provide a better fit.

5. Cut and Sew

Cut and Sew garments are made from patterned pieces of compression fabric sewn together to make a complete garment. This process allows for choice of positioning and type of seams, linings and closures, as well as the design of the pattern to construct the garment.

Making informed choices

Our team includes practising lymphoedema trained therapists who work together with you so you can make informed choices.

To support you with the measurement, prescription and ordering of compression garments and wraps, we provide:

- practical information
- methodical clarification
- case studies

“

*“When planning client treatment,
consider combinations of modalities.
Our clinical advisors can help
map your approach to client
management.”*



Compression definitions

Inlay yarn gives the compression garment its elastic properties and controls the dosage.

Body yarn delivers the thickness and stiffness of the textile, contributing to the garment's properties including suppleness, wicking and sheerness versus opacity.

Medical compression stocking fabric is made from inlay yarns and body yarns that are knitted together.

Graduated compression garments have the greatest pressure at their bases and reduce in pressure as the compression garment goes up the arm or leg.

In order to maintain medically efficacious dosages, it is very important to replace garments regularly (generally every six months).

Static stiffness The stiffness of a compression fabric describes the resistance to expansion such as when an area of the body swells or when muscles contract.

Dosage is the inward pressure that a garment exerts on the body as a result of its elastic recoil.

Improving your results

Before you order a compression product...

Determine your treatment goals and a management plan that is specific, realistic and tailored to the needs of your client. It's important to know what you want to achieve in order to make the best choice.

Review, continue and reassess regularly

Regular clinical reviews provide the opportunity to monitor clients' progress and changes, consider how the plan is meeting client needs and determine what might be needed in the future. This is the opportunity to either continue with the prescribed compression or reassess and select a more suitable alternative.

Asking effective questions

Our collection of therapist resources will prompt the critical thinking required for successful garment prescription. These are available through our online learning platform, or contact us to request a copy.

RAL classification

Compression garments from Haddenham Healthcare are standardised using the Reichs Ausschuss für Lieferbedingungen (RAL) classification, which is the organisation responsible for quality and technical standards in Germany.

	RAL CCL1	RAL CCL2	RAL CCL3	RAL CCL4
LOWER LIMB COMPRESSION	18 - 21mmHg	23-32mmHg	34-46mmHg	49mmHg and over
UPPER LIMB COMPRESSION	15 - 21mmHg	23-32mmHg	34-46mmHg	X

References

Bjork, R. and Ehmann, S. (2019). S.T.R.I.D.E. Professional Guide to Compression Garment Selection for the Lower Extremity. Journal of Wound Care, 28(Sup6a), pp.1–44.

Lee, N. and Wigg, J. (2013). Getting the Right Fit: Made-to-measure Garments for Lymphoedema Management. British Journal of Community Nursing, 18(Sup4), pp.S28–S33.

Together with you on the path to achieve clinical effectiveness

Clinical advisors

- Develop effective strategies through guided clinical reasoning
- Discuss the rationale around the choice of compression treatment based on your lymphoedema assessment
- Guidance with measuring and sizing

Discuss your cases with our clinical advisors. They have a wealth of knowledge and experience to help problem-solve compression therapy options.

Schedule phone/virtual appointments with our clinical advisors

www.hadhealth.com.au/bookings

E-learning

- Increase your options of problem-solving solutions by learning from the experience of others
- Improve your understanding of the ways Haddenham Healthcare products can be used in clinical practice
- See how research has improved understanding and application of compression therapy
- Access a range of practical tips and guides

Haddenham Healthcare are continually adding to the selection of online resources on our e-learning platform. These have been designed by practising clinicians and educators. You can work through topics of interest at your own pace. Each e-learning unit is broken into modules that you can quickly refer to when problem-solving ways to support your clients.

Register now for immediate access

www.hadhealth.com.au/e-learning



E-news

Be on the list to find out as soon as we have news, including the latest product information and releases, upcoming events, new online courses and guides to assist you in your clinical practice.

Sign up at www.hadhealth.com.au



“Haddenham Healthcare provide a variety of ways to develop your expertise and enhance client care.”

Customer service

- Support with orders, quotes, delivery and exchanges
- Request product guidance to complete orders

Reach out to the customer service team if you have questions at any stage of the ordering process.

Contact our customer service team

Phone 03 9544 5515 or

email sales@hadhealth.com.au

Events

- Build your skills in application and measuring of Haddenham Healthcare products
- Enhance your understanding of cost-effective compression therapy options
- Expand your network of colleagues

Join our webinars and live events that we host throughout the year. These events are an opportunity to meet members of the Haddenham Healthcare team and gain better understanding of the diverse range of compression therapy options that Haddenham Healthcare provide and how you can use these in your clinical practice.

For information and registration

www.hadhealth.com.au

Resources

- Enhance your understanding of Haddenham Healthcare options with clinic samples and information
- Access training support material
- Register for events and learning opportunities

Contact us with any resource-related queries. We also welcome your feedback, questions and suggestions on how we can better tailor our information to support you in your clinical practice.

Our website is a good place to start

www.hadhealth.com.au

Connect with therapists and learn from each other by sharing experiences, successes and challenges. Interact provides an opportunity to exchange ideas and talk through possible solutions to improve the awareness of treatment choices. **Go to www.hadhealth.com.au for information**

Interact

Feel Good

At Haddenham Healthcare, we appreciate that treating lymphoedema, lipoedema and chronic oedema is not just about prescribing compression garments. The daily habits and attitude of those with this condition make a considerable difference to how they feel and the possibility of stabilising or improving their health.

We have created resources to help your clients build positive habits and feel good. These are designed to support you to educate and motivate them towards the goal of self-efficacy. Refer to these resources as inspiration when educating and planning goals with your clients.

www.hadhealth.com.au/feel-good





Lower Limb

Upper Limb

easywrap

Confuware

Midline

Essentials

Lymphtech

Lymphtech

Essentials

Midline

Comfware

easywrap

Upper Limb

Lower Limb

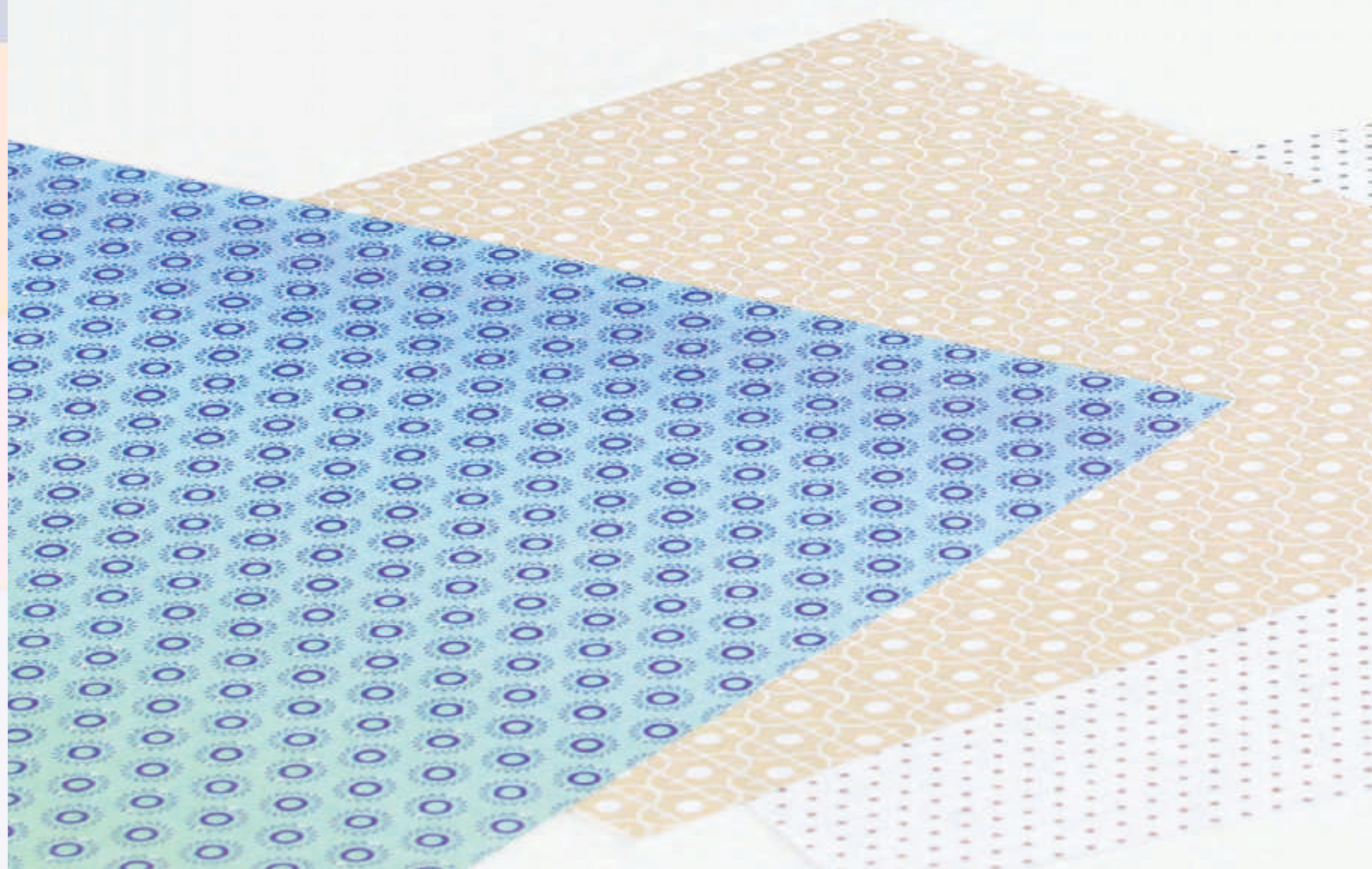



Freedom to choose

Lower Limb Garments

FABRIC	KNITTING TECHNIQUE	COMPRESSION CLASS	PAGE
<i>Pertex</i> Light	Flat Knit	1	16 ▶
<i>Pertex</i>	Flat Knit	2 3	20 ▶
GOLDPUNKT	Flat Knit	2 3 4	24 ▶
veni	Circular Knit	1 2 3	28 ▶
STAR Cotton	Circular Knit	1 2	32 ▶
Dokus	Circular Knit	2 3	36 ▶
veni Compression Shorts	Circular Knit	2	40 ▶
Microfine TOECAP	Cut and Sew	20-36mmHg	41 ▶
STRIDE	Circular Knit	2	42 ▶
<i>eto</i> <i>Grace</i> for Lipoedema	Cut and Sew	25-30mmHg	44 ▶
LOWER LIMB COMPRESSION FOR CHILDREN			46 ▶
LOWER LIMB SUPPORT INFORMATION			48 ▶
<i>Comfiwave</i>	Whole-Garment Knitting	15-21mmHg	Comfiwave tab ▶
easywrap	Compression Wrap System	20-30mmHg 30-40mmHg	Easywrap tab ▶

Lower Limb

Upper Limb

easywrap

Comfiwave

Midline

Essentials

Lymphtech



Pertex

Light

CCL1

18-21mmHg

A uniquely light and stretchy flat knit

Pertex Light is a Class 1 flat knit soft, stretchy, conforming fabric.

Product insight

Combine the unique features and benefits of Pertex Light with those of flat knit garments.

Features

Soft body yarns

Large range of prescription combinations including extra wide circumferences

Unique stretchy knit

Benefits

Soft and stretchy with less elastic intensity, helping to bridge shaping discrepancies

Easy to fit, don and doff





Well tolerated for long periods of time

Material Composition: Polyamide and Elastane

“It never ceases to amaze me how successful Pertex Light can be for all sorts of patients”



1 Choose Style and Compression Class *Choose all your Pertex Light garment and anklet options* ▶

							
	COMPRESSION CLASS	TOE CAP	ANKLET	BELOW KNEE		THIGH HIGH	
		SINGLE	PAIR	PAIR	+ GRIP TOPS	PAIR	+ GRIP TOPS
STOCK	1	×	090	901 SIZE 7-15	900 SIZE 7-15	×	903 SIZE 7-15
PRICE			\$64	\$130	\$160		\$215
MTO	1	×	090	901	900	902	903
PRICE			\$64	\$130	\$160	\$190	\$215
CUSTOM	1	PX-TOE	090CM	901CM	900CM	902CM	903CM
PRICE		\$174	\$65	\$150	\$162	\$203	\$215

							
	COMPRESSION CLASS	THIGH HIGH + WAISTBAND			TIGHTS		
		LEFT LEG	BILATERAL	RIGHT LEG	LEFT LEG	RIGHT LEG	
STOCK	1	×	×	×	×	×	×
MTO	1	905	904	906	908	907	909
PRICE		\$107	\$214	\$107	\$390	\$390	\$390
CUSTOM	1	905CM	904CM	906CM	908CM	907CM	909CM
PRICE		\$230	\$463	\$230	\$619	\$619	\$619

2 Choose Size

STOCK items available in Size 7 to 15 in **STANDARD WIDTH** **EXTRA WIDE** shown in green **STANDARD WIDTH** shown in black

Circumferences cm	4	5	6	7	8	9	10	11	12	13	14	15
t WAIST	65-75	70-80	70-80	75-85	75-85	80-90	80-90	85-95	85-95	90-105	90-105	95-110
j BUTTOCKS	85-105	90-110	90-110	95-115	95-115	100-120	100-120	105-125	105-125	110-130	110-130	115-135
g UPPER THIGH	46-65 44-53	48-68 46-56	50-71 48-59	52-74 50-62	54-77 52-65	56-81 54-69	58-85 56-73	60-89 58-77	62-93 60-81	64-98 62-86	66-103 64-91	68-108 66-96
d BELOW KNEE	29-40 28-32	31-42 30-34	32-44 31-36	34-46 33-38	35-48 34-40	37-50 36-42	38-52 37-44	40-54 39-46	41-56 40-48	43-59 41-51	44-62 43-54	46-65 44-57
c MID CALF	31-39 29-33	33-41 31-35	34-43 33-37	36-45 35-39	37-47 36-41	39-49 38-43	40-51 39-45	42-53 41-47	43-55 42-49	45-58 44-52	46-61 45-55	48-64 47-58
b ANKLE	19-21	20-22	21-23	22-24	23-25	24-26	25-27	26-28	27-29	28-31	29-33	30-36

TIP

If your measurements are above the circumference measures of **j**, consider **LOOSE FIT**. If they are below the **t** range, consider the **DRAWSTRING WAIST** - available in the **SPECIAL OPTIONS**.

3 Choose Leg Length

Stock items available in **REGULAR LEG LENGTH**

Straight distance cm	SHORT	REGULAR	LONG
A-g THIGH HIGH AND TIGHTS	57-67	68-80	81-90
A-d BELOW KNEE	33-37	38-43	44-48

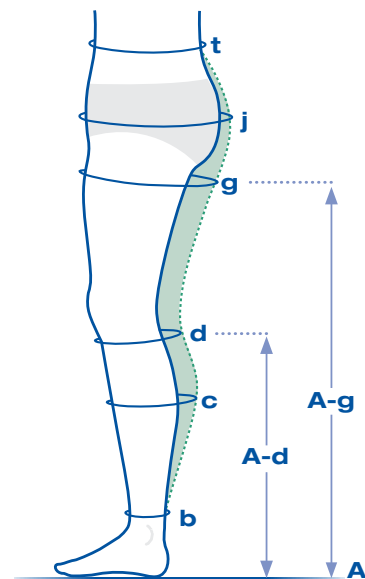

4 Choose Toe



5 Choose Foot Length

Stock items available in **REGULAR FOOT LENGTH**



Straight distance cm	SHORT	REGULAR	LONG
CLOSED TOE BACK OF HEEL TO END OF LONGEST TOE	21 - 23	23 - 26	26 - 29
OPEN TOE HEEL TO BALL OF FOOT AT BIG TOE	13 - 15	15 - 18	18 - 21



6 Choose Grip Top

			
3cm STRONG PLAIN A - d default SIZE 4-11	5cm STRONG PLAIN A - g default ALL SIZES A - d default SIZE 12-15	5cm STRONG LACE	5cm FINE LACE

7 Choose Colour

	
BEIGE default	BLACK

Special Options

Please specify the desired position and dimensions of pockets, linings, straps, fastening and zips on your order form.

									
	DRAWSTRING WAIST	ELASTIC WAISTBAND default	NO PANTY COMPRESSION default	HALF PANTY COMPRESSION	FULL PANTY COMPRESSION	LOOSE FIT	NO GUSSET	FLY VERTICAL	FLY HORIZONTAL
MTO	FREE	FREE	FREE	FREE	FREE	\$16	\$16	\$16	\$16
CUSTOM	FREE	FREE	FREE	FREE	FREE	\$16	\$16	\$16	\$16

									
	T-HEEL	PARTIAL LINING	ZIP	POCKET	VELCRO STRAP	VELCRO FASTENING	MALE GUSSET	OPEN FRONT	SLANT FOOT
MTO	FREE	X	X	X	\$11 each	\$52	\$16	\$16	FREE
CUSTOM	FREE	\$52	\$52	\$52	\$11 each	\$52	\$16	\$16	FREE

 See Page 48 for [Lower Limb Support Information](#) ▶

Pertex Light Anklet



STOCK **MTO** **CUSTOM**

1 Choose Compression Class Pertex Light options page 17 ▶

2 Choose Size

Circumferences cm	1	2	3	4	5	6
b ANKLE	17-19	19-21	21-23	23-25	25-27	27-29
a METATARSAL HEAD	17-19	19-21	21-23	23-25	25-27	27-29

3 Choose Anklet Length

	REGULAR A-b ¹	15 - 17cm
	SHORT A-b	10 - 12cm

4 Choose Foot Length Pertex Light options page 18 ▶

5 Choose Toe Pertex Light options page 18 ▶

6 Choose Colour Pertex Light options page 19 ▶

Pertex

CCL2

CCL3

23-32mmHg

34-46mmHg

Soft, supportive flat knit

Pertex Class 2 and 3 offer greater static stiffness than Pertex Light yet are still soft and stretchy.

Product insight

Combine the unique features and benefits of Pertex with those of flat knit garments.

Features

Constructed with stronger inlay yarns than Pertex Light

Different knitting parameters to Pertex Light creating a stiffer fabric

The same soft body yarns as in Pertex Light

Cost effective compression

Benefits

Firm consistent hold of moderate to severe oedema

Soft and stretchy for comfort

Extra wide size options reducing the need for custom made

Stock and made to order options providing effective compression

Material Composition: Polyamide and Elastane









“Your go-to garment. You will keep coming back to Pertex for its reliable management of oedema”

1 Choose Style and Compression Class

Choose all your Pertex garment and anklet options ►

									
		TOE CAP		ANKLET		BELOW KNEE		THIGH HIGH	
	COMPRESSION CLASS	SINGLE	PAIR	PAIR	+ GRIP TOPS	PAIR	+ GRIP TOPS		
STOCK	2	×	092	921 SIZE 7-15	920 SIZE 7-15	×	923 SIZE 7-15		
PRICE			\$64	\$130	\$160		\$215		
MTO	2	×	092	921	920	922	923		
PRICE	3		093	931	930	932	933		
			\$64	\$130	\$160	\$190	\$215		
CUSTOM	2	PX-TOE	092CM	921CM	920CM	922CM	923CM		
PRICE	3	PX-TOE	093CM	931CM	930CM	932CM	933CM		
		\$174	\$65	\$150	\$162	\$203	\$215		

									
		THIGH HIGH + WAISTBAND			TIGHTS				
	COMPRESSION CLASS	LEFT LEG	BILATERAL	RIGHT LEG	LEFT LEG		RIGHT LEG		
STOCK	2	×	×	×	×	×	×		
MTO	2	925	924	926	928	927	929		
PRICE	3	935	934	936	938	937	939		
		\$107	\$214	\$107	\$390	\$390	\$390		
CUSTOM	2	925CM	924CM	926CM	928CM	927CM	929CM		
PRICE	3	935CM	934CM	936CM	938CM	937CM	939CM		
		\$230	\$463	\$230	\$619	\$618	\$618		

2 Choose Size

STOCK items available in Size 7 to 15 in **STANDARD WIDTH** **EXTRA WIDE** shown in green **STANDARD WIDTH** shown in black

Circumferences cm	4	5	6	7	8	9	10	11	12	13	14	15
t WAIST	65-75	70-80	70-80	75-85	75-85	80-90	80-90	85-95	85-95	90-105	90-105	95-110
j BUTTOCKS	85-105	90-110	90-110	95-115	95-115	100-120	100-120	105-125	105-125	110-130	110-130	115-135
g UPPER THIGH	46-48 44-46	48-50 46-48	50-52 48-50	52-54 50-52	54-56 52-54	56-58 54-56	58-60 56-58	60-62 58-60	62-64 60-62	64-66 62-64	66-68 64-66	68-70 66-68
d BELOW KNEE	29-31 28-30	31-33 30-31	32-34 31-33	34-36 33-34	35-37 34-36	37-39 36-37	38-40 37-39	40-42 39-40	41-43 40-41	43-45 41-43	44-47 43-45	46-48 44-47
c MID CALF	31-33 29-31	33-35 31-33	34-36 33-35	36-38 35-36	37-39 36-38	39-41 38-39	40-42 39-41	42-44 41-42	43-45 42-44	45-47 44-45	46-49 45-47	48-50 47-49
b ANKLE	19-20	20-21	21-22	22-23	23-24	24-25	25-26	26-27	27-28	28-29	29-30	30-31

TIP

If your measurements are above the circumference measures of **j**, consider **LOOSE FIT**. If they are below the **t** range, consider the **DRAWSTRING WAIST** - available in the **SPECIAL OPTIONS**.

3 Choose Leg Length

Stock items available in **REGULAR LEG LENGTH**

Straight distance cm	SHORT	REGULAR	LONG
A-g THIGH HIGH AND TIGHTS	60-67	68-75	76-82
A-d BELOW KNEE	33-37	38-42	43-46

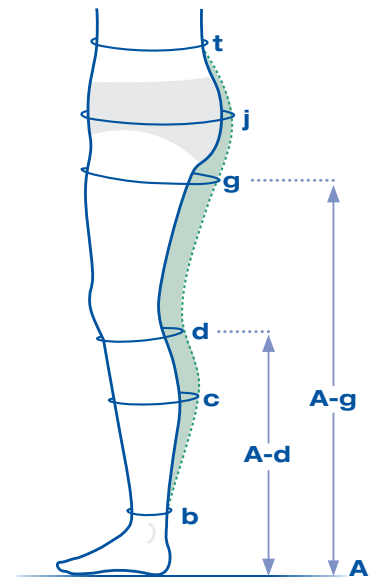

4 Choose Toe



5 Choose Foot Length

Stock items available in **REGULAR FOOT LENGTH**

Straight distance cm	SHORT	REGULAR	LONG
CLOSED TOE BACK OF HEEL TO END OF LONGEST TOE	21 - 23	23 - 26	26 - 29
OPEN TOE HEEL TO BALL OF FOOT AT BIG TOE	13 - 15	15 - 18	18 - 21



6 Choose Grip Top

			
3cm STRONG PLAIN <i>A - d default</i> SIZE 4-11	5cm STRONG PLAIN <i>A - g default</i> ALL SIZES <i>A - d default</i> SIZE 12-15	5cm STRONG LACE	5cm FINE LACE

7 Choose Colour

	
BEIGE <i>default</i>	BLACK

Special Options

Please specify the desired position and dimensions of pockets, linings, straps, fastening and zips on your order form.

									
	DRAWSTRING WAIST	ELASTIC WAISTBAND <i>default</i>	NO PANTY COMPRESSION <i>default</i>	HALF PANTY COMPRESSION	FULL PANTY COMPRESSION	LOOSE FIT	NO GUSSET	FLY VERTICAL	FLY HORIZONTAL
MTO	FREE	FREE	FREE	FREE	FREE	\$16	\$16	\$16	\$16
CUSTOM	FREE	FREE	FREE	FREE	FREE	\$16	\$16	\$16	\$16

									
	T-HEEL	PARTIAL LINING	ZIP	POCKET	VELCRO STRAP	VELCRO FASTENING	MALE GUSSET	OPEN FRONT	SLANT FOOT
MTO	FREE	X	X	X	\$11 each	\$52	\$16	\$16	FREE
CUSTOM	FREE	\$52	\$52	\$52	\$11 each	\$52	\$16	\$16	FREE

 See Page 48 for [Lower Limb Support Information](#) ►

Pertex Anklet



STOCK **MTO** **CUSTOM**

1 Choose Compression Class Pertex options page 21 ►

2 Choose Size

Circumferences cm	1	2	3	4	5	6
b ANKLE	17-19	19-21	21-23	23-25	25-27	27-29
a METATARSAL HEAD	17-19	19-21	21-23	23-25	25-27	27-29

3 Choose Anklet Length

	REGULAR A-b ¹	15 - 17cm
	SHORT A-b	10 - 12cm

4 Choose Foot Length Pertex options page 22 ►

5 Choose Toe Pertex options page 22 ►

6 Choose Colour Pertex options page 23 ►

GOLDPUNKT

CCL2

23-32mmHg

CCL3

34-46mmHg

CCL4

49mmHg +

Our flat knit offering greater static stiffness

Firm and supportive with silky yarns inside to aid donning and doffing.

Product insight

Combine the unique features and benefits of Goldpunkt with those of flat knit garments.

Features

High stiffness

Multiple body yarns creating a denser fabric

Specifically chosen body yarns to form a silky layer inside the garment

Benefits

Provide good resistance to rebound and severe oedema

Bridges shaping discrepancies

Reduces the risk of trauma and skin damage during donning and doffing







“Don’t presume this garment will be difficult to don and doff. The silky inside makes it surprisingly easy”

Material Composition: Polyamide and Elastane

1 Choose Style and Compression Class

Choose all your Goldpunkt garment and anklet options ►

	COMPRESSION CLASS						
		TOE CAP	ANKLET	BELOW KNEE		THIGH HIGH	
		SINGLE	PAIR	PAIR	+ GRIP TOPS	PAIR	+ GRIP TOPS
	2	×	094	941	940	942	943
MTO	3	×	096	961	960	962	963
	4	×	098	981	980	982	983
PRICE			\$67	\$125	\$150	\$199	\$223
	2	GP-TOE	094CM	941CM	940CM	942CM	943CM
CUSTOM	3	GP-TOE	096CM	961CM	960CM	962CM	963CM
	4	GP-TOE	098CM	981CM	980CM	982CM	983CM
PRICE		\$167	\$63 each	\$153 each	\$166 each	\$220 each	\$233 each

	COMPRESSION CLASS						
		THIGH HIGH + WAISTBAND				TIGHTS	
		LEFT LEG	BILATERAL	RIGHT LEG	LEFT LEG	RIGHT LEG	
	2	945	944	946	948	947	949
MTO	3	965	964	966	968	967	969
	4	985	984	986	988	987	989
PRICE		\$112	\$224	\$112	\$390	\$390	\$390
	2	945CM	944CM	946CM	948CM	947CM	949CM
CUSTOM	3	965CM	964CM	966CM	968CM	967CM	969CM
	4	985CM	984CM	986CM	988CM	987CM	989CM
PRICE		\$237	\$474	\$237	\$669	\$669	\$669

2 Choose Size

EXTRA WIDE shown in green STANDARD WIDTH shown in black

Circumferences cm	4	5	6	7	8	9	10	11	12	13	14	15
t WAIST	65-75	70-80	70-80	75-85	75-85	80-90	80-90	85-95	85-95	90-105	90-105	95-110
j BUTTOCKS	85-105	90-110	90-110	95-115	95-115	100-120	100-120	105-125	105-125	110-130	110-130	115-135
g UPPER THIGH	46-48 44-46	48-50 46-48	50-52 48-50	52-54 50-52	54-56 52-54	56-58 54-56	58-60 56-58	60-62 58-60	62-64 60-62	64-66 62-64	66-68 64-66	68-70 66-68
d BELOW KNEE	29-31 28-30	31-33 30-31	32-34 31-33	34-36 33-34	35-37 34-36	37-39 36-37	38-40 37-39	40-42 39-40	41-43 40-41	43-45 41-43	44-47 43-45	46-48 44-47
c MID CALF	31-33 29-31	33-35 31-33	34-36 33-35	36-38 35-36	37-39 36-38	39-41 38-39	40-42 39-41	42-44 41-42	43-45 42-44	45-47 44-45	46-49 45-47	48-50 47-49
b ANKLE	19-20	20-21	21-22	22-23	23-24	24-25	25-26	26-27	27-28	28-29	29-30	30-31

TIP If your measurements are above the circumference measures of **j**, consider LOOSE FIT. If they are below the **t** range, consider the DRAWSTRING WAIST - available in the **SPECIAL OPTIONS**.

3 Choose Leg Length

Straight distance cm	SHORT	REGULAR	LONG
A-g THIGH HIGH AND TIGHTS	60-67	68-75	76-82
A-d BELOW KNEE	33-37	38-42	43-46

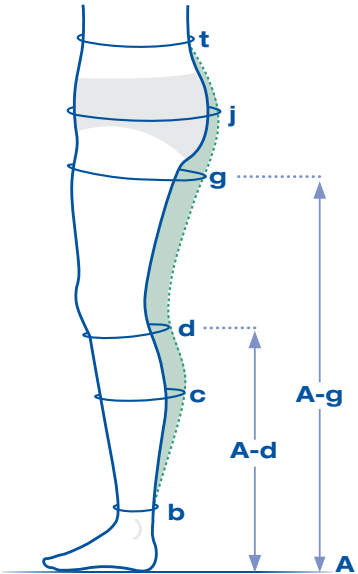

4 Choose Toe



5 Choose Foot Length

Straight distance cm	SHORT	REGULAR	LONG
CLOSED TOE BACK OF HEEL TO END OF LONGEST TOE	21 - 23	23 - 26	26 - 29
OPEN TOE HEEL TO BALL OF FOOT AT BIG TOE	13 - 15	15 - 18	18 - 21

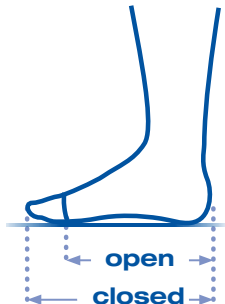

6 Choose Grip Top



3cm STRONG PLAIN
A - d default
SIZE 4-11



5cm STRONG PLAIN
A - g default
ALL SIZES
A - d default
SIZE 12-15



5cm STRONG LACE



5cm FINE LACE

7 Choose Colour



BEIGE
default



BLACK

Special Options

Please specify the desired position and dimensions of pockets, linings, straps, fastening and zips on your order form.



DRAWSTRING WAIST



ELASTIC WAISTBAND
default



NO PANTY COMPRESSION
default



HALF PANTY COMPRESSION



FULL PANTY COMPRESSION



LOOSE FIT



NO GUSSET



FLY VERTICAL



FLY HORIZONTAL

MTO	FREE	FREE	FREE	FREE	FREE	\$16	\$16	\$16	\$16
CUSTOM	FREE	FREE	FREE	FREE	FREE	\$16	\$16	\$16	\$16



T-HEEL



PARTIAL LINING



ZIP



POCKET



VELCRO STRAP



VELCRO FASTENING



MALE GUSSET



OPEN FRONT



SLANT FOOT

MTO	FREE	X	X	X	\$11 each	\$52	\$16	\$16	FREE
CUSTOM	FREE	\$52	\$52	\$52	\$11 each	\$52	\$16	\$16	FREE

See Page 48 for [Lower Limb Support Information](#) ►

GOLDPUNKT Anklet

MTO **CUSTOM**

1 Choose Compression Class [Goldpunkt options page 25](#) ►

2 Choose Size

Circumferences cm	1	2	3	4	5	6
b ANKLE	17-19	19-21	21-23	23-25	25-27	27-29
a METATARSAL HEAD	17-19	19-21	21-23	23-25	25-27	27-29

3 Choose Anklet Length



REGULAR
A-b¹

15 - 17cm



SHORT
A-b

10 - 12cm

4 Choose Foot Length

[Goldpunkt options page 26](#) ►

5 Choose Toe

[Goldpunkt options page 26](#) ►

6 Choose Colour

[Goldpunkt options page 27](#) ►

veni

CCL1

18-21mmHg

CCL2

23-32mmHg

CCL3

34-46mmHg

A versatile circular knit

Veni is a soft, stretchy and conforming fabric with a wide choice of colours and patterns.

Product insight

Combine the unique features and benefits of Veni with those of circular knit garments.

Features

Innovative stretching knit

Advanced microfibres

Soft and fine mesh structure

Benefits

Semi opaque design for professional and everyday wear

Easy to don and doff

Gentle on the skin



“Veni offers you a wide choice while providing effective compression therapy”

Material Composition: Polyamide and Elastane

1 Choose Style and Compression Class

Choose all your Veni garment and anklet options ►



	COMPRESSION CLASS	ANKLET			BELOW KNEE		THIGH HIGH	
		PAIR	PAIR	+ GRIP TOPS	PAIR	+ GRIP TOPS		
STOCK	1	X	501	X	X	X		
	2	053	533	X	X	X		
PRICE		\$43	\$66					
MTO	1	050	501	500	505	509		
	2	053	533	532	537	541		
	3	056	565	564	569	573		
PRICE		\$43	\$66	\$89	\$86	\$112		
CUSTOM	1	050CM	501CM	500CM	505CM	509CM		
	2	053CM	533CM	532CM	537CM	541CM		
	3	056CM	565CM	564CM	569CM	573CM		
PRICE		\$36 each	\$74 each	\$87 each	\$112 each	\$127 each		



	COMPRESSION CLASS	THIGH HIGH + WAISTBAND			TIGHTS		
		LEFT LEG	BILATERAL	RIGHT LEG	LEFT LEG	RIGHT LEG	
STOCK	1	X	X	X	X	X	X
	2	X	X	X	X	X	X
MTO	1	517	513	521	527	525	529
	2	549	545	553	558	557	561
	3	581	577	585	591	589	593
PRICE		\$59	\$118	\$59	\$112	\$112	\$112
CUSTOM	1	517CM	513CM	521CM	527CM	525CM	529CM
	2	549CM	545CM	553CM	558CM	557CM	561CM
	3	581CM	577CM	585CM	591CM	589CM	593CM
PRICE		\$145	\$288 each	\$145	\$280	\$280	\$280

2 Choose Size

STOCK items available **STANDARD WIDTH** **EXTRA WIDE** shown in green **STANDARD WIDTH** shown in black

Circumferences cm	1	2	3	4	5	6	7	8
t WAIST	65-75	70-80	75-85	80-90	85-95	90-105	95-110	100-120
j BUTTOCKS	85-105	90-110	95-115	100-120	105-125	110-130	115-135	120-140
g UPPER THIGH	46-55 43-48	48-59 45-51	52-63 49-55	56-66 53-59	60-69 57-63	64-72 61-66	67-75 64-69	70-78 67-72
c MID CALF	31-35 29-33	33-37 31-35	35-39 33-37	37-42 35-39	39-45 37-42	41-47 39-45	43-52 41-48	45-56 43-51
b ANKLE	18-20	20-22	22-24	24-26	26-28	28-30	30-32	32-34

TIP

If your measurements are above the circumference measures of **j**, consider **LOOSE FIT**. If they are below the **t** range, consider the **DRAWSTRING WAIST** - available in the **SPECIAL OPTIONS**.

3 Choose Leg Length

Stock items available in **REGULAR LEG LENGTH**

Straight distance cm	SHORT	REGULAR	LONG
A-g THIGH HIGH AND TIGHTS	57-67	68-80	81-90
A-d BELOW KNEE	33-37	38-43	44-48

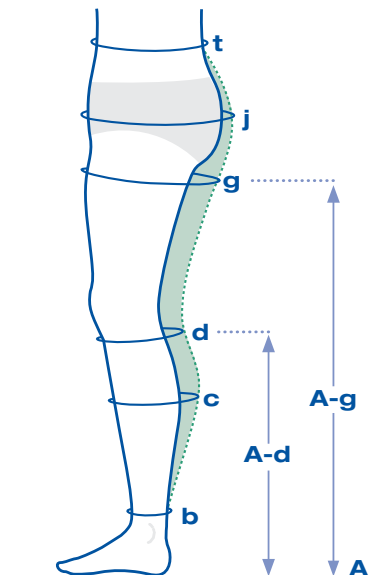

4 Choose Toe

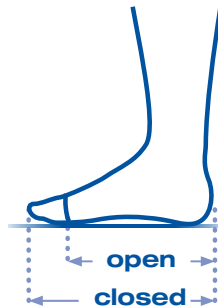

5 Choose Foot Length

Stock items available in **REGULAR FOOT LENGTH**

Straight distance cm	SHORT	REGULAR	LONG
CLOSED TOE BACK OF HEEL TO END OF LONGEST TOE	21 - 23	23 - 26	26 - 29
OPEN TOE HEEL TO BALL OF FOOT AT BIG TOE	13 - 15	15 - 18	18 - 21

6 Choose Grip Top



3cm STRONG PLAIN
A - d default



5cm STRONG PLAIN
A - g default



5cm STRONG LACE



5cm FINE LACE

7 Choose Pattern



8 Choose Colour

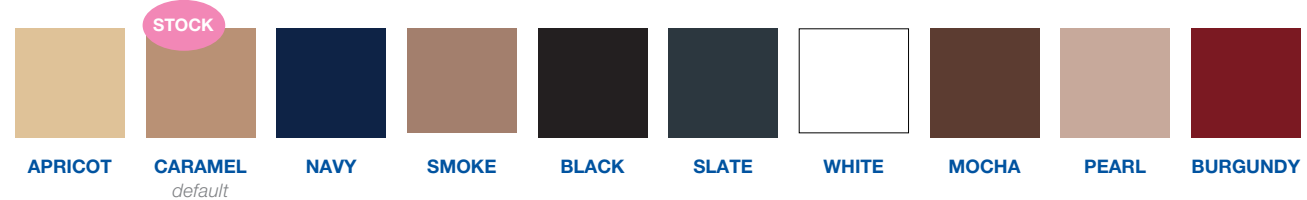

Special Options

	KNITTED WAIST <i>default</i>	ELASTIC WAISTBAND	DRAWSTRING WAIST	NO PANTY COMPRESSION <i>default</i>	HALF PANTY COMPRESSION	FULL PANTY COMPRESSION	LOOSE FIT
MTO	FREE	FREE	FREE	FREE	FREE	FREE	FREE
CUSTOM	FREE	FREE	FREE	FREE	FREE	FREE	FREE

	MALE GUSSET	NO GUSSET	FLY VERTICAL	FLY HORIZONTAL	OPEN FRONT
MTO	\$16	\$16	\$16	\$16	\$16
CUSTOM	\$16	\$16	\$16	\$16	\$16

See Page 48 for [Lower Limb Support Information](#) ►

veni Anklet

STOCK **MTO** **CUSTOM**

1 Choose Compression Class [Veni options page 29](#) ►

2 Choose Size

Circumferences cm	1	2	3	4	5	6	7	8
b ANKLE	18-20	20-22	22-24	24-26	26-28	28-30	30-32	32-34
a METATARSAL HEAD	17-21	19-23	21-25	23-27	25-29	27-31	29-33	31-35

3 Choose Anklet Length

REGULAR A-b ¹	15 - 17cm
SHORT A-b	10 - 12cm

4 Choose Foot Length

[Veni options page 30](#) ►

5 Choose Toe

[Veni options page 30](#) ►

6 Choose Colour

[Veni options page 31](#) ►

STAR Cotton

CCL1

CCL2

18-21mmHg

23-32mmHg

Great for sensitive skin

A soft yet firm fabric featuring 100% cotton in contact with the skin.

Product insight

Combine the unique features and benefits of Star Cotton with those of circular knit garments.

Features

100% cotton against the skin

Cotton body yarns create a soft, yet firm circular knit fabric

Stiffer fabric

Benefits

Provides good resistance for mild to moderate oedema

Good for clients with intolerance to non-natural fibres



Matt opaque garment to blend in for everyday wear









“Build on the positive awareness of cotton to help support your patient’s acceptance of compression”

Material Composition: Cotton and Elastane

1 Choose Style and Compression Class Choose all your Star Cotton garment and anklet options ►

					
		ANKLET	BELOW KNEE		THIGH HIGH
	COMPRESSION CLASS	PAIR	PAIR	+ GRIP TOPS	PAIR + GRIP TOPS
STOCK	1	×	341	×	×
	2	×	741	×	×
PRICE			\$87		\$147
MTO	1	034	341	340	345
	2	074	741	740	742
PRICE		\$56	\$87	\$113	\$120
CUSTOM	1	034CM	341CM	340CM	345CM
	2	074CM	741CM	740CM	742CM
PRICE		\$37 each	\$94 each	\$108 each	\$128 each

							
		THIGH HIGH + WAISTBAND			TIGHTS		
	COMPRESSION CLASS	LEFT LEG	BILATERAL	RIGHT LEG	LEFT LEG	RIGHT LEG	
STOCK	1	×	×	×	×	×	
	2	×	×	×	×	×	
MTO	1	357	353	361	367	365	
	2	747	746	748	750	749	
PRICE		\$72	\$146	\$72	\$147	\$147	
CUSTOM	1	357CM	353CM	361CM	367CM	365CM	
	2	747CM	746CM	748CM	750CM	749CM	
PRICE		\$139 each	\$278 each	\$139 each	\$278	\$278	

2 Choose Size

STOCK items available **STANDARD WIDTH** **EXTRA WIDE** shown in green **STANDARD WIDTH** shown in black

Circumferences cm	1	2	3	4	5	6	7	8
t WAIST	65-75	70-80	75-85	80-90	85-95	90-105	95-110	100-120
j BUTTOCKS	85-105	90-110	95-115	100-120	105-125	110-130	115-135	120-140
g UPPER THIGH	46-55 43-48	48-59 45-51	52-63 49-55	56-66 53-59	60-69 57-63	64-72 61-66	67-75 64-69	70-78 67-72
c MID CALF	31-35 29-33	33-37 31-35	35-39 33-37	37-42 35-39	39-45 37-42	41-47 39-45	43-52 41-48	45-56 43-51
b ANKLE	18-20	20-22	22-24	24-26	26-28	28-30	30-32	32-34

TIP

If your measurements are above the circumference measures of **j**, consider **LOOSE FIT**. If they are below the **t** range, consider the **DRAWSTRING WAIST** - available in the **SPECIAL OPTIONS**.

3 Choose Leg Length

Stock items available in **REGULAR LEG LENGTH**

Straight distance cm	SHORT	REGULAR	LONG
A-g THIGH HIGH AND TIGHTS	60-67	68-75	76-82
A-d BELOW KNEE	33-37	38-42	43-46

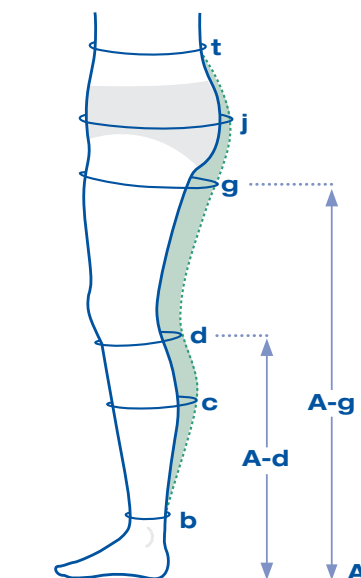

4 Choose Toe



5 Choose Foot Length

Stock items available in **REGULAR FOOT LENGTH**

Straight distance cm	SHORT	REGULAR	LONG
CLOSED TOE BACK OF HEEL TO END OF LONGEST TOE	21 - 23	23 - 26	26 - 29
OPEN TOE HEEL TO BALL OF FOOT AT BIG TOE	13 - 15	15 - 18	18 - 21



6 Choose Grip Top



3cm STRONG PLAIN
A - d default



5cm STRONG PLAIN
A - g default



5cm STRONG LACE



5cm FINE LACE

7 Choose Colour



BEIGE
default



BLACK

Special Options



KNITTED WAIST
default



ELASTIC WAISTBAND



DRAWSTRING WAIST



NO PANTY COMPRESSION
default



HALF PANTY COMPRESSION



FULL PANTY COMPRESSION



LOOSE FIT

MTO

FREE FREE FREE FREE FREE FREE FREE

CUSTOM

FREE FREE FREE FREE FREE FREE FREE



MALE GUSSET



NO GUSSET



FLY VERTICAL



FLY HORIZONTAL



OPEN FRONT

MTO

\$16 \$16 \$16 \$16 \$16

CUSTOM

\$16 \$16 \$16 \$16 \$16

i See Page 48 for **Lower Limb Support Information** ▶

STAR Cotton Anklet

MTO

CUSTOM

1 Choose Compression Class Star Cotton options page 33 ▶

2 Choose Size

Circumferences cm	1	2	3	4	5	6	7	8
b ANKLE	18-20	20-22	22-24	24-26	26-28	28-30	30-32	32-34
a METATARSAL HEAD	17-21	19-23	21-25	23-27	25-29	27-31	29-33	31-35

3 Choose Anklet Length



REGULAR
A-b¹

15 - 17cm



SHORT
A-b

10 - 12cm

4 Choose Foot Length
Star Cotton options page 34 ▶

5 Choose Toe
Star Cotton options page 34 ▶

6 Choose Colour
Star Cotton options page 35 ▶

Doktus

CCL2

23-32mmHg

CCL3

34-46mmHg

Robust and firm circular knit

A robust and comfortable fabric available in stronger compression.

Product insight

Combine the unique features and benefits of Doktus with those of circular knit garments.

Features

Sturdy body yarns are knitted to create robust garment

Opaque fabric

Stiffest circular knit within the Haddenham range

Benefits

Designed to distribute pressure and contain the oedema



“Doktus is a good choice for those who lead an active life”

Material Composition: Polyamide and Elastane

1 Choose Style and Compression Class

Choose all your Doktus garment and anklet options ►



	COMPRESSION CLASS	ANKLET	BELOW KNEE		THIGH HIGH	
		PAIR	PAIR	+ GRIP TOPS	PAIR	+ GRIP TOPS
MTO	2	070	701	700	702	703
	3	072	721	720	722	723
PRICE		\$43	\$66	\$89	\$86	\$112
CUSTOM	2	070CM	701CM	700CM	702CM	703CM
	3	072CM	721CM	720CM	722CM	723CM
PRICE		\$36 each	\$74 each	\$87 each	\$112 each	\$127 each



	COMPRESSION CLASS	THIGH HIGH + WAISTBAND			TIGHTS		
		LEFT LEG	BILATERAL	RIGHT LEG	LEFT LEG	RIGHT LEG	
MTO	2	707	707	708	717	709	718
	3	707	707	728	737	729	738
PRICE		\$59	\$118	\$59	\$112	\$112	\$112
CUSTOM	2	707CM	707CM	708CM	717CM	709CM	718CM
	3	707CM	707CM	728CM	737CM	729CM	738CM
PRICE		\$145	\$288 each	\$145	\$280	\$280	\$280

2 Choose Size

EXTRA WIDE shown in green STANDARD WIDTH shown in black

Circumferences cm	1	2	3	4	5	6	7	8
t WAIST	65-75	70-80	75-85	80-90	85-95	90-105	95-110	100-120
j BUTTOCKS	85-105	90-110	95-115	100-120	105-125	110-130	115-135	120-140
g UPPER THIGH	46-55 43-48	48-59 45-51	52-63 49-55	56-66 53-59	60-69 57-63	64-72 61-66	67-75 64-69	70-78 67-72
c MID CALF	31-35 29-33	33-37 31-35	35-39 33-37	37-42 35-39	39-45 37-42	41-47 39-45	43-52 41-48	45-56 43-51
b ANKLE	18-20	20-22	22-24	24-26	26-28	28-30	30-32	32-34

TIP

If your measurements are above the circumference measures of **j**, consider LOOSE FIT. If they are below the **t** range, consider the DRAWSTRING WAIST - available in the **SPECIAL OPTIONS**.

3 Choose Leg Length

Straight distance cm	SHORT	REGULAR	LONG
A-g THIGH HIGH AND TIGHTS	60-67	68-75	76-82
A-d BELOW KNEE	33-37	38-42	43-46

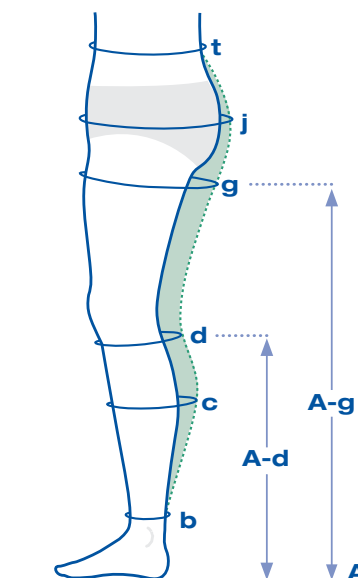

4 Choose Toe



CLOSED



OPEN



FOOTLESS

5 Choose Foot Length

Straight distance cm	SHORT	REGULAR	LONG
CLOSED TOE BACK OF HEEL TO END OF LONGEST TOE	21 - 23	23 - 26	26 - 29
OPEN TOE HEEL TO BALL OF FOOT AT BIG TOE	13 - 15	15 - 18	18 - 21



6 Choose Grip Top

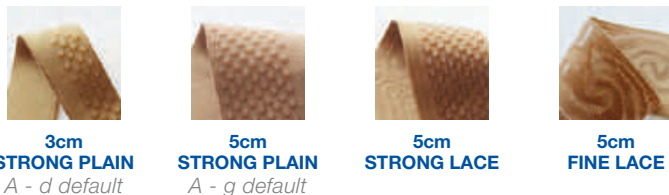

7 Choose Colour

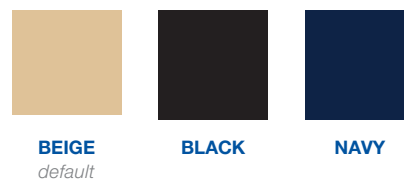

Special Options

	KNITTED WAIST <i>default</i>	ELASTIC WAISTBAND	DRAWSTRING WAIST	NO PANTY COMPRESSION <i>default</i>	HALF PANTY COMPRESSION	FULL PANTY COMPRESSION	LOOSE FIT
MTO	FREE	FREE	FREE	FREE	FREE	FREE	FREE
CUSTOM	FREE	FREE	FREE	FREE	FREE	FREE	FREE
	MALE GUSSET	NO GUSSET	FLY VERTICAL	FLY HORIZONTAL	OPEN FRONT		
MTO	\$16	\$16	\$16	\$16	\$16		
CUSTOM	\$16	\$16	\$16	\$16	\$16		

See Page 48 for [Lower Limb Support Information](#) ►

Doktus Anklet

MTO **CUSTOM**

1 Choose Compression Class [Doktus options page 37](#) ►

2 Choose Size

Circumferences cm	1	2	3	4	5	6	7	8
b ANKLE	18-20	20-22	22-24	24-26	26-28	28-30	30-32	32-34
a METATARSAL HEAD	17-21	19-23	21-25	23-27	25-29	27-31	29-33	31-35

3 Choose Anklet Length

	REGULAR A-b ¹	15 - 17cm
	SHORT A-b	10 - 12cm

4 Choose Foot Length
[Doktus options page 38](#) ►

5 Choose Toe
[Doktus options page 38](#) ►

6 Choose Colour
[Doktus options page 39](#) ►

veni

Compression Shorts

CCL2

23-32mmHg

Features

Graduated compression in the leg

Compressive panty section

Suitable for

Primary lymphoedema of the trunk and thighs

Lymphoedema post-malignant melanoma

Genital oedema due to any cause

Post-gynaecological surgery

Lipoedema



1 Choose Style

CYCLING SHORTS

SINGLE

CAPRI SHORTS

SINGLE

STOCK
558
\$116

STOCK
560
\$128

2 Choose Colour

STOCK

APRICOT
STOCK

BLACK

3 Choose Size

Circumferences cm

XS
S
M
L
XL
XXL
XXXL

		XS	S	M	L	XL	XXL	XXXL
t	WAIST	65-75	75-85	85-95	95-105	105-115	115-125	125-135
j	BUTTOCKS	85-95	95-105	105-115	115-125	125-135	135-145	145-155
g	UPPER THIGH	43-51	47-55	49-56	55-63	59-67	63-71	67-74
f	MID THIGH	43-48	47-52	49-54	55-61	59-65	63-69	67-72
d	BELOW KNEE	25-28	27-30	29-33	31-35	35-39	37-41	40-44
c	MID CALF	27-30	29-32	33-37	36-40	39-43	42-46	45-51

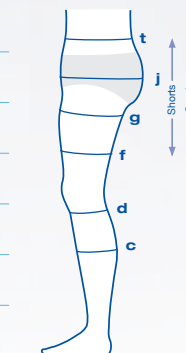
TIP

Please be aware that these garments have a full compressive panty section. You may want to consider upsizing. Our Clinical Advisors can help guide your choice.

Microfine TOECAP

An ultra-thin and smooth fabric that trims to fit without fraying



20-36mmHg
compression



No need to
bandage toes



Easy to measure
and fit

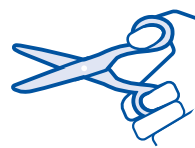

Trim to fit without
fraying

Circumferences cm

XXS

XS

S

M

L

XL



BASE OF TOES

19 - 24

21 - 23

23 - 25

25 - 27

27 - 29

29 - 31

STOCK



SAND

218S-0

218S-1

218S-2

218S-3

218S-4

218S-5

STOCK



BLACK

218B-0

218B-1

218B-2

218B-3

218B-4

218B-5

STOCK

\$69 each

CUSTOM

\$163 each

STRIDE

CCL2

23-32mmHg

Lymph active socks

For those who are on their feet and active throughout the day, and require extra cushioning to the sole of the foot.



Features

Plush and comfortable sole

Stylish and versatile design

Easy to get on and off

RAL Class 2 compression

Available in four colours



BLACK



BLACK/GREY



NAVY



WHITE WITH
BLUE STRIPE

Material Composition: Polyamide and Elastane

Lower Limb
Upper Limb
easywrap
Comfware
Midline
Essentials
Lymphtech

1 Choose Style



BELOW KNEE

PAIR

STOCK	821 \$65
MTO	821 \$65

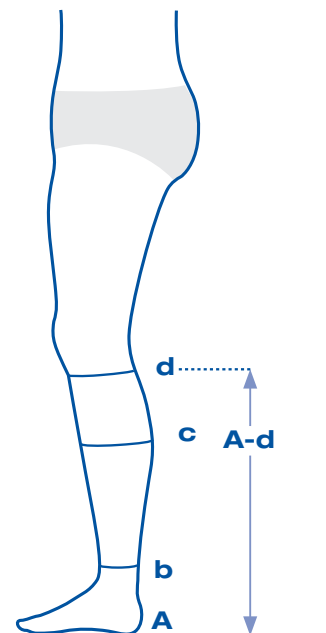

2 Choose Colour

STOCK

BLACK	GREY	NAVY	WHITE WITH BLUE STRIPE

3 Choose Size

Circumferences cm	XXS	XS	S	M	L	XL	XXL
c MID CALF	29-33	31-35	33-37	35-39	37-42	39-45	41-48
b ANKLE	18-20	20-22	22-24	24-26	26-28	28-30	30-32

4 Choose Leg Length

Stock items available in **REGULAR LEG LENGTH**

Length cm	SHORT	REGULAR
A-d BELOW KNEE	33 - 37	38 - 43

5 Choose Foot Length

Stock items available in **REGULAR FOOT LENGTH**

Length cm	SHORT	REGULAR	LONG	EXTRA LONG
BACK OF HEEL TO END OF LONGEST TOE	21 - 23	24 - 26.5	27 - 29.5	29.5 - 31.5

etoGrace garments

for Lipoedema

25-30mmHg

Supportive and breathable

Cut and sew garments, made
to your exact measurements.

Features

Graduated compression profile range of 25-30mmHg

Suitable for machine washing at 30 degrees

Stiffest circular knit within the Haddenham range

Benefits

Suitable for day-to-day wear to improve symptoms
associated with lipoedema.

Suitable for immediate use post liposuction for
lipoedema of the legs, thighs, hips, abdomen and
buttocks.

Donning and doffing video guide available for
consumers.



Our clinical team have developed video guides
that are essential viewing prior to measuring
www.hadhealth.com.au/e-learning



1 Choose Style



TIGHTS



FOOTLESS TIGHTS



CAPRI

**FIXED PRICE
CUSTOM MADE**

Measurements fit within the sizes listed on the measurement form

ETO-G134
\$320

ETO-G133A
\$220

ETO-G133
\$204

CUSTOM

ETO-G134CM
from \$384

ETO-G133ACM
from \$264

ETO-G133CM
from \$245

2 Record Patient Measurements

etoGrace
Elastic Compression Tights for Lymphedema
20-Denier Compression

QUESTIONS FOR THE THERAPIST (please tick if YES)
 1. Have you been unable to submit with your order?
 2. Have you ordered an Eto Grace garment previously?
 Your Name: _____
 1. For support with using this form, please see the Eto Grace measuring guide - hadhealth.com.au/guide
 2. Check that the leg is as straight as possible - only measure to the knee.
 3. If any circumstances are outside the values listed, a guide will be issued and a clinical adviser will contact you.

SELECT COLOUR
 WHITE NUDE BLACK

WAIST FASTENINGS
 ZIP HOOK & EYE

PUBIS OPTION
 PUBIS OPEN CROTCH

E-mail: sales@hadhealth.com.au Tel: 03 9544 5515 Fax: 03 9544 5512 www.hadhealth.com

3 Choose Colour



NUDE



BLACK



WHITE



Ready to order?

Use **Eto Grace Form** available at www.hadhealth.com.au/forms

Include patient photos with your order.

Special Options

Waist Fastenings

Optional

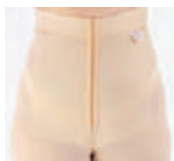

HOOK & EYE



ZIP

Additional \$40

Pubis Option

Optional



OPEN CROTCH

FREE

Lower limb compression for children

A guide to Haddenham products to consider for paediatric use.



Pertex Light is a Class 1 flat knit soft, stretchy, conforming fabric.

Anklet available in Size 1 with a b circumference 17-19cm

Made to Order available in three foot lengths - Short is 21-23cm

Made to Order offering two leg lengths:

- Regular (A-b1)
- Short (A-b)

Choose:

- Open or closed toe
- Two colours - black or beige

Custom Made Pertex Light



Available in all lower limb styles - toe cap, anklet, below knee, thigh high with waist band and tights with all the custom options.



For more details of lower limb Pertex Light options, see **Page 16** ►

PERTEX LIGHT ANKLET WITH MICROFINE TOECAP



Pertex Class 2 and 3 offers greater static stiffness than Pertex Light yet is still soft and stretchy.

Custom Made Pertex



Available in all lower limb styles - toe cap, anklet, below knee, thigh high with waist band and tights with all the custom options.



For more details of lower limb Pertex options, see **Page 20** ►





Microfine TOECAP

An ultra-thin and smooth fabric that trims to fit without fraying.

Available in STOCK in size XXS and XS

Two colours to choose from - black or beige

Class 2 (20-36mmHg; French standard)

i For more details of Microfine Toecap options, see **Page 41** ▶

Comfiwave®

Compression garments that promote softening of tissues whilst enhancing the movement of fluid through them.

Gives a therapeutic pressure of 15-21mmHg

Smaller sizes for Comfiwave Below Knee available:

- Short length - A-d 32 - 37cm
- Ankle circumference 17 - 22cm

NEW Comfiwave Toecap size M to fit a circumference around the metatarsal head of 20 - 27cm

i For more details of lower limb Comfiwave options, see **Page 97** ▶



easywrap®

Easywrap garments consist of overlapping, single-layer textile bands that are worn over a protective liner.



Custom Made Easywrap

Available in all lower limb Easywrap styles - foot, leg and thigh with knee.



For more details of lower limb Easywrap options, see **Page 77** ▶

Lower limb support information



Lower Limb

Upper Limb

easywrap

Comfware

Midline

Essentials

Lymphtech

Sizing

Circumferences

For **STOCK** and **MADE TO ORDER** garments



t WAIST
Narrowest waist/above the hips

j BUTTOCKS
Widest circumference around the buttocks

g UPPER THIGH
Approx. 2 finger widths/3 - 4cm below the crotch (taken at the back of the leg)

d BELOW KNEE
Approx. 2 finger widths/3 - 4cm below the popliteal crease

c MID CALF
Midway between b1 and d

b ANKLE
Approx. 2 finger widths/3 - 4cm above the malleolus

Foot Length

**BACK OF HEEL TO
END OF LONGEST
TOE**

	SHORT FOOT	REGULAR FOOT	LONG FOOT
Centimetres	21 - 24	24 - 26	27 - 29
AUS Mens Shoe Size	< 5	5-9	≥10
AUS Womens Shoe Size	< 7	7-11	≥12



Reference sizing for **Open Toe**

**HEEL TO BALL OF
FOOT AT BIG TOE**

Centimetres	13 - 15	15 - 18	18 - 21
-------------	---------	---------	---------

Grip tops



3cm Strong Plain Pertex Light, Pertex, Goldpunkt, Star Cotton, Doktus



3cm Strong Plain Veni



5cm Strong Lace



5cm Strong Plain (Pertex Light, Pertex, Goldpunkt, Star Cotton, Doktus)



5cm Strong Plain (Veni)



5cm Fine Lace

Waistbands



DRAWSTRING WAIST

The drawstring waist is a good option if you need to accommodate wider hips than waist or a fluctuating waist circumference.



ELASTIC WAISTBAND

Non-silicone elastic. This option may not be suitable when the circumference of the hips is much wider than the waist. This is the default waist option for flat knit tights.



KNITTED WAISTBAND

Knitted ribbed waistband designed to stretch. This is the default waist option for circular knit tights. Only available for circular knits.

Feet



SLANT FOOT

Slant foot can be requested for open or closed toe flat knit garments.

NOTE - Garments with a closed toe have NO COMPRESSION in the toe box.

Panty



NO GUSSET

Open pubis



VERTICAL FLY FRONT

Closed pubis with vertical fly at front



HORIZONTAL FLY FRONT

Closed pubis with horizontal fly at front



OPEN FRONT

Tights with a waist band but no material at the front / back of panty.



MALE GUSSET

Larger gusset to increase comfort for male genitals



LOOSE FIT

Full panty but made more generously with two seams to accommodate larger abdomens or to allow for extra comfort if someone is intolerant of compression over the abdomen.



FULL PANTY COMPRESSION

The garments will continue to be made with graduated compression all the way to the waist with the same thread and tension as what you have asked for in the legs.



HALF PANTY COMPRESSION

The panty section will be knitted with half compression. That is, every second row will have compression inlay threads.

NOTE - If you do not specify FULL or HALF compression on your panty garments, they will be made with NO COMPRESSION. There will be a definitive change in the appearance of the panty section of the garment compared with the leg section.

Closures

The following closures are available for Made to Order and Custom Made flat knit garments. If you are considering using any of these options, it could be beneficial to discuss your ideas with one of our Clinical Advisors.



ZIPS

Zips can be added in any location but do remember that this will alter the properties of the fabric at that location. For example, it won't stretch longitudinally where the zip is sewn in.



VELCRO STRAPS

Velcro straps can be added in any location along the length of the leg. This however does not allow the garment to perform the same function as a wrapping device. The two edges need to be carefully aligned to prevent puckering.



VELCRO FASTENINGS

The Velcro runs vertically down the length of the garment to oppose the two sides and close the garment.





Lower Limb

Upper Limb

easywrap

Confidure

Midline

Essentials

Lymphtech

Lymphtech

Essentials

Midline

Comfluvare

easywrap

Upper Limb

Lower Limb



Freedom to choose

Upper Limb Garments

FABRIC	KNITTING TECHNIQUE	COMPRESSION CLASS	PAGE
Pertex Light	Flat Knit	1	56 ▶
Pertex	Flat Knit	2 3	58 ▶
GOLDPUNKT	Flat Knit	2 3	60 ▶
Venex	Circular Knit	1 2	64 ▶
STAR Cotton	Circular Knit	1 2	66 ▶
Doktus	Circular Knit	2 3	68 ▶
Microfine GLOVE	Cut and Sew	20-36mmHg	70 ▶
UPPER LIMB COMPRESSION FOR CHILDREN			72 ▶
UPPER LIMB SUPPORT INFORMATION			74 ▶
Comfiwave	Whole-Garment Knitting	15-21mmHg	Comfiwave tab ▶
easywrap	Compression Wrap System	20-30mmHg	Easywrap tab ▶

Pertex Light

CCL1

15-21mmHg

A uniquely light and stretchy flat knit

Pertex Light is a Class 1 flat knit soft, stretchy, conforming fabric.

Product insight

Combine the unique features and benefits of Pertex Light with those of flat knit garments.

Features

Unique stretchy knit

Soft body yarns

Large range held in stock including extra wide circumferences

Available as custom made if required

Benefits

Gently conforms around the elbow providing comfort without the need for shaping

Soft and stretchy with less elastic intensity, helping to bridge shaping discrepancies

Easy to fit, don and doff

Well tolerated for long periods of time

Material Composition: Polyamide and Elastane



1 Choose Style and Compression Class *EXTRA WIDE options available in STOCK



	COMPRESSION CLASS	MITTEN NO THUMB single	MITTEN single	GLOVE single Left Right	SLEEVE single	+ GRIP TOP single	SLEEVE + MITTEN single	+ GRIP TOP single	SLEEVE + GLOVE single	+ GRIP TOP single
STOCK	1	×	106	105	143	*145	×	×	×	×
PRICE			\$39	\$160	\$51	\$63				
MTO	1	×	106	105	143	145	×	×	×	×
PRICE			\$39	\$160	\$51	\$63				
CUSTOM	1	150CM	106CM	105CM	143CM	145CM	180CM	181CM	184CM	185CM
PRICE		\$79	\$99	\$208	\$147	\$159	\$179	\$189	\$329	\$342

2 Choose Size EXTRA WIDE shown in green

Circumferences cm	XS	S	M	L
g AXILLA	26-32 20-26	28-35 21-28	34-48 24-34	40-50 30-40
e ELBOW CREASE	18-22	19-24	22-28	26-32
c WRIST CREASE	14-16	16-19	20-24	22-26
a BASE OF FINGERS	17-18	18-20	20-22	22-24

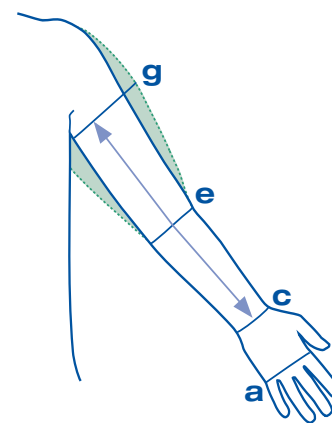

3 Choose Sleeve Length STOCK items available in both lengths

Length cm	REGULAR	LONG
c-g WRIST CREASE TO AXILLA	40-44	44-50

4 Choose Sleeve Grip Top

STOCK

3cm STRONG PLAIN	5cm STRONG PLAIN	5cm STRONG LACE	5cm FINE LACE

5 Choose Colour

STOCK

BEIGE <i>default</i>	BLACK

Special Options



MTO	\$50	\$55	\$50	\$10 each	\$55	\$53	\$68
CUSTOM	\$50	\$55	\$50	\$10 each	\$55	\$53	\$68

i See Page 74 for Upper Limb Support Information ▶

Pertex

CCL2

CCL3

23-32mmHg

34-46mmHg

Soft, supportive flat knit

Pertex Class 2 and 3 offer greater static stiffness than Pertex Light yet are still soft and stretchy.

Product insight

Combine the unique features and benefits of Pertex with those of flat knit garments.

Features

The same soft body yarns as in Pertex Light

Custom-made compression with defined elbow shaping

Constructed with heavier inlay yarns than Pertex Light

Different knitting parameters than Pertex Light creating a stiffer fabric

Benefits

Firm consistent hold for moderate to severe oedema

Minimised irritation associated with fabric bunching and upper limb movement

Soft and stretchy for comfort

Variations can be well accommodated

Material Composition: Polyamide and Elastane



1 Choose Style and Compression Class

	COMPRESSION CLASS	MITTEN NO THUMB single	MITTEN single	GLOVE single Left Right	SLEEVE single	+ GRIP TOP single	SLEEVE + MITTEN single	+ GRIP TOP single	SLEEVE + GLOVE single	+ GRIP TOP single
STOCK	2	×	206	205	×	×	×	×	×	×
PRICE			\$51	\$160						
MTO	2	×	206	205	×	×	×	×	×	×
	3	×	306	305	×	×	×	×	×	×
PRICE			\$51	\$160						
CUSTOM	2	250CM	206CM	205CM	333CM	203CM	234CM	204CM	284CM	285CM
	3	350CM	306CM	305CM	331CM	311CM	332CM	312CM	384CM	385CM
PRICE		\$79	\$99	\$208	\$147	\$159	\$179	\$189	\$329	\$342

2 Choose Glove Size

Circumference cm	XS	S	M	L
a PALM AT BASE OF FINGERS	17-18	18-20	20-22	22-24

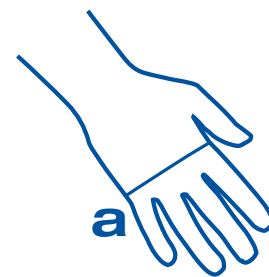

3 Choose Sleeve Grip Top

3cm STRONG PLAIN	5cm STRONG PLAIN	5cm STRONG LACE	5cm FINE LACE

4 Choose Colour

BEIGE <i>default</i>	BLACK

Special Options

PARTIAL LINING	ZIP	POCKET	VELCRO STRAP	VELCRO FASTENING	SHOULDER CAP WITH VELCRO BRA ATTACHMENT	SHOULDER CAP & ADJUSTABLE STRAP	
CUSTOM	\$50	\$55	\$50	\$10 each	\$55	\$53	\$68

See Page 74 for [Upper Limb Support Information](#) ►

GOLDPUNKT

CCL2

CCL3

23-32mmHg

34-46mmHg

Our flat knit offering greater static stiffness

Firm and supportive with silky yarns inside to aid donning and doffing.

Product insight

Combine the unique features and benefits of Goldpunkt with those of flat knit garments.

Features

High stiffness

Multiple body yarns creating a denser fabric

Specifically chosen body yarns to form a silky layer inside the garment

Benefits

Provide good resistance to rebound and severe oedema

Bridges shaping discrepancies

Reduces the risk of trauma and skin damage during donning and doffing

Material Composition: Polyamide and Elastane



1 Choose Style and Compression Class

COMPRESSION CLASS	MITTEN NO THUMB single		MITTEN single		GLOVE single		SLEEVE + GRIP TOP single		SLEEVE + MITTEN + GRIP TOP single		SLEEVE + GLOVE + GRIP TOP single	
					Left	Right						
MTO	2	×	209	207	×	×	×	×	×	×	×	×
PRICE			\$51	\$160								
CUSTOM	2	251CM	209CM	207CM	315CM	213CM	316CM	214CM	288CM	289CM		
	3	351CM	309CM	307CM	317CM	313CM	318CM	314CM	388CM	389CM		
PRICE		\$79	\$99	\$208	\$147	\$159	\$179	\$189	\$329	\$342		

2 Choose Glove Size

Circumference cm	XS	S	M	L
a PALM AT BASE OF FINGERS	17-18	18-20	20-22	22-24

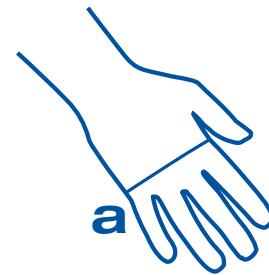

3 Choose Sleeve Grip Top

3cm STRONG PLAIN	5cm STRONG PLAIN	5cm STRONG LACE	5cm FINE LACE

4 Choose Colour

BEIGE	BLACK

Special Options

PARTIAL LINING	ZIP	POCKET	VELCRO STRAP	VELCRO FASTENING	SHOULDER CAP WITH VELCRO BRA ATTACHMENT	SHOULDER CAP & ADJUSTABLE STRAP	
CUSTOM	\$50	\$55	\$50	\$10 each	\$55	\$53	\$68

See Page 74 for [Upper Limb Support Information](#) ►



Flat-knit custom made sleeves

- Shaped to reduce fabric folding into the elbow crease, reduce friction and to accommodate range of movement.
- Custom made to meet the complex shaping of individuals' arms.
- Suit your clients' needs with choice of 'all-in-one' design, separate custom pieces, or mix and match a custom sleeve with Stock or MTO hand piece.

Need help with measuring?

Our clinical team are here to help
clinical@hadhealth.com.au

3 Steps to Success

- 1** Measure your client while they are sitting in a chair alongside a table or plinth. Position their arm in supination, with a relaxed elbow (approx. 45 degrees).
- 2** Mark the measuring points on the anterior aspect of the arm before you begin to take the measurements.
- 3** Record the circumference and corresponding length measurements on the custom made order form.



Venex

CCL1

CCL2

15-21mmHg

23-32mmHg

A versatile circular knit

Veni is a soft, stretchy and conforming fabric with a wide choice of colours and patterns.

Product insight

Combine the unique features and benefits of Veni with those of circular knit garments.

Features

Advanced microfibres knitted to create a fine mesh structure

Soft, wide cuff at wrist

Large, soft elbow stretch zone

Benefits

Wicks moisture away from the body keeping the wearer cooler and comfortable

Appropriate for prophylactic and early intervention programmes

Increases comfort at elbow and ease of fitting

Thumb gusset for added comfort and greater hand dexterity

Material Composition: Polyamide and Elastane



1 Choose Style and Compression Class *EXTRA WIDE options available in STOCK



	COMPRESSION CLASS	SLEEVE single	+ GRIP TOP single	SLEEVE + MITTEN single	+ GRIP TOP single
STOCK	1	X	*101	X	*102
	2	X	*221	X	*222
PRICE			\$55		\$76
MTO	1	103	101	104	102
	2	223	221	224	222
PRICE		\$41	\$55	\$62	\$76
CUSTOM	1	103CM	101CM	104CM	102CM
	2	223CM	221CM	224CM	222CM
PRICE		\$147	\$159	\$167	\$179

2 Choose Size EXTRA WIDE shown in green

Circumferences cm	XXS	XS	S	M	L
g AXILLA	29-33 26-28	33-36 28-32	36-40 32-36	40-44 36-40	44-48 40-44
e ELBOW CREASE	21-23	23-25	25-27	28-30	30-32
c¹ 4cm ABOVE WRIST	14-15	15-17	17-19.5	19.5-22.5	22.5-26
a PALM AT BASE OF FINGERS	13-16	14-18	16-21	18-24	21-27

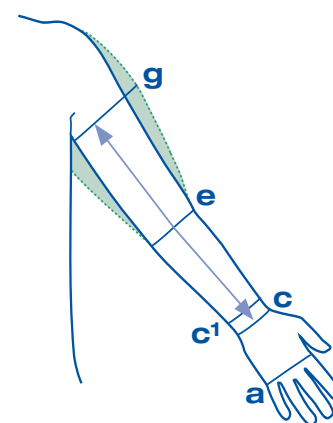

3 Choose Sleeve Length STOCK items available in both lengths

Length cm	REGULAR	LONG
c-g WRIST CREASE TO AXILLA	40-44	44-50

4 Choose Sleeve Grip Top

STOCK

3cm STRONG PLAIN	5cm STRONG PLAIN	5cm STRONG LACE	5cm FINE LACE

Special Options

SHOULDER CAP WITH VELCRO BRA ATTACHMENT	SHOULDER CAP & ADJUSTABLE STRAP

MTO	\$50	\$65
CUSTOM	\$50	\$65

5 Choose Colour

STOCK

BEIGE <i>default</i>	CARAMEL	SLATE
BLACK	SMOKE	PEARL

See Page 74 for Upper Limb Support Information ▶

STAR Cotton

CCL1

CCL2

15-21mmHg

23-32mmHg

Great for sensitive skin

A soft yet firm fabric featuring 100% cotton in contact with the skin.

Product insight

Combine the unique features and benefits of Star Cotton with those of circular knit garments.

Features

100% cotton against the skin

Cotton body yarns create a soft, yet firm, circular knit fabric

Stiffer fabric

Soft, wide cuff at wrist

Large soft elbow stretch zone

Benefits

Provides good resistance for mild to moderate oedema

Good for clients with intolerance to non-natural fibres

Increased comfort at the elbow

Thumb gusset for added comfort and greater hand dexterity

Material Composition: Cotton and Elastane



1 Choose Style and Compression Class *EXTRA WIDE options available in STOCK



	COMPRESSION CLASS	SLEEVE single	+ GRIP TOP single	SLEEVE + MITTEN single	+ GRIP TOP single
STOCK	1	X	X	X	X
	2	*261	X	*262	X
PRICE		\$58		\$76	
MTO	1	161	163	162	164
	2	261	263	262	264
PRICE		\$58	\$71	\$76	\$87
CUSTOM	1	161CM	163CM	162CM	164CM
	2	261CM	263CM	262CM	264CM
PRICE		\$147	\$159	\$167	\$179

2 Choose Size EXTRA WIDE shown in green

Circumferences cm

	XS	S	M	L
g AXILLA	33-36 28-32	36-40 32-36	40-44 36-40	44-48 40-44
e ELBOW CREASE	23-25	25-27	28-30	30-32
c¹ 4cm ABOVE WRIST	15-17	17-19.5	19.5-22.5	22.5-26
a PALM AT BASE OF FINGERS	14-18	16-21	18-24	21-27

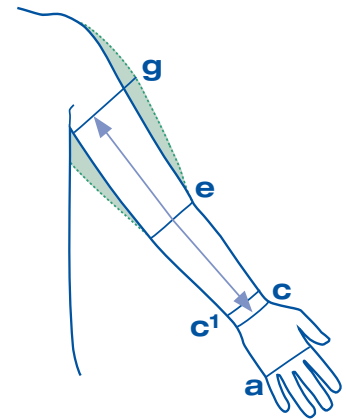

3 Choose Sleeve Length STOCK items available in both lengths

Length cm

	REGULAR	LONG
c-g WRIST CREASE TO AXILLA	40-44	44-50

4 Choose Sleeve Grip Top



3cm STRONG PLAIN



5cm STRONG PLAIN



5cm STRONG LACE



5cm FINE LACE

5 Choose Colour



BEIGE default



BLACK

Special Options



SHOULDER CAP WITH VELCRO BRA ATTACHMENT



SHOULDER CAP & ADJUSTABLE STRAP

MTO	\$50	\$65
CUSTOM	\$50	\$65

See Page 74 for Upper Limb Support Information ►

Doktus

CCL2

23-32mmHg

CCL3

34-46mmHg

Robust and firm circular knit

A robust and comfortable fabric available in stronger compression.

Product insight

Combine the unique features and benefits of Doktus with those of circular knit garments.

Features

Sturdy body yarns are knitted to create robust garment

Opaque fabric

Stiffest circular knit within the Haddenham range

Soft, wide cuff at wrist

Large soft elbow stretch zone

Benefits

Designed to distribute pressure and contain the oedema

Increases comfort at elbow

Thumb gusset for added comfort and greater hand dexterity

Material Composition: Polyamide and Elastane



1 Choose Style and Compression Class



	COMPRESSION CLASS	SLEEVE single	+ GRIP TOP single	SLEEVE + MITTEN single	+ GRIP TOP single
STOCK	2	×	201	×	202
PRICE			\$55		\$76
MTO	2	215	201	217	202
	3	216	301	219	302
PRICE		\$41	\$55	\$62	\$76
CUSTOM	2	215CM	201CM	217CM	202CM
	3	216CM	301CM	219CM	302CM
PRICE		\$147	\$159	\$167	\$179

2 Choose Size **EXTRA WIDE** shown in green

Circumferences cm	XS	S	M	L
g AXILLA	33-36 28-32	36-40 32-36	40-44 36-40	44-48 40-44
e ELBOW CREASE	23-25	25-27	28-30	30-32
c¹ 4cm ABOVE WRIST	15-17	17-19.5	19.5-22.5	22.5-26
a PALM AT BASE OF FINGERS	14-18	16-21	18-24	21-27

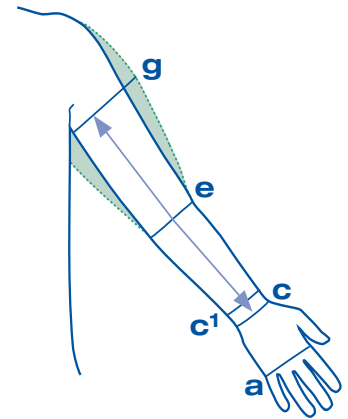

3 Choose Sleeve Length **STOCK** items available in both lengths

Length cm	REGULAR	LONG
c-g WRIST CREASE TO AXILLA	40-44	44-50

4 Choose Sleeve Grip Top

STOCK				
	3cm STRONG PLAIN <i>default</i>	5cm STRONG PLAIN	5cm STRONG LACE	5cm FINE LACE

5 Choose Colour

STOCK			
	BEIGE <i>default</i>	BLACK	NAVY

Special Options



SHOULDER CAP
WITH VELCRO BRA
ATTACHMENT



SHOULDER CAP
& ADJUSTABLE STRAP

MTO	\$50	\$65
CUSTOM	\$50	\$65

See Page 74 for **Upper Limb Support Information** ►

Microfine GLOVE

An ultra-thin and smooth fabric that trims to fit without fraying



20-36mmHg
compression



No need to
bandage fingers



Easy to measure
and fit

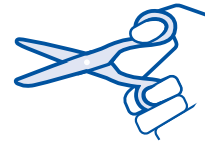

Trim to fit without
fraying

Circumferences cm

XXS

XS

S

M

L



		XXS	XS	S	M	L
a	PALM AT BASE OF FINGERS	14-16	16-18	18-20	20-22	22-24
b	PALM LEVEL WITH THUMB WEB SPACE	15-17	17-19	19-21	21-23	24-26

STOCK



SAND

208S-0

208S-1

208S-2

208S-3

208S-4

STOCK



BLACK

208B-0

208B-1

208B-2

208B-3

208B-4

STOCK

\$89.00 each

CUSTOM

\$189.00 each



FROM LEFT - BEIGE PERTEX LIGHT MITTEN, BLACK MICROFINE GLOVE AND BEIGE GOLDPUNKT GLOVE

Upper limb compression for children

A guide to Haddenham products to consider for paediatric use.



Easywrap Arm and Hand are adjustable upper limb garments for mild to moderate lymphoedema.

Hand piece available in XS (b < 19cm across palm)

Microfine Glove available in XXS (b 15-17cm across palm)



Custom Made Easywrap

Easywrap Hand and Easywrap Arm available in custom made for smaller sizes.



For more details of upper limb Easywrap options, see **Page 77** ▶



**EASYWRAP HAND
WITH MICROFINE
GLOVE**



Microfine GLOVE

An ultra-thin and smooth fabric that trims to fit without fraying.

Available in STOCK in size XXS and XS

Light compression Class 2 (20-36mmHg; French Standard)



Custom Made Microfine

Available in custom made for smaller sizes



For more details of upper limb Microfine Glove options, see **Page 70** ▶

Comfiwave®

Comfiwave garments promote softening of tissues whilst enhancing fluid movement.

Gives a therapeutic pressure of 15-21 mmHg

Fine weave in glove garments

Glove and Glove to Elbow available in Small



For more details of upper limb Comfiwave options, see **Page 97** ▶



Upper limb support information



Lower Limb

Upper Limb

easywrap

Comfluare

Midline

Essentials

Lymphtech

Sizing

Circumferences

For **STOCK** and **MADE TO ORDER** garments

g AXILLA
2 fingers width or 3cm below
the axilla

e ELBOW CREASE

c¹ APPROX. 4cm ABOVE c

c WRIST CREASE
Circumference over ulnar
styloid process

a PALM AT BASE OF
FINGERS

Special options



PARTIAL LINING

Available for flat knit garments. This is positioned in the elbow crease unless otherwise specified.



ZIP

Available for flat knit garments

Note A zip in an upper limb garment doesn't always aid independent donning.



POCKET

Available for flat knit garments. This is positioned in the elbow crease unless otherwise specified.



VELCRO STRAPS

Available for flat knit garments. Velcro straps can be added in any location along the length of arm sleeve. This however does not allow the garment to perform the same function as a WRAP. The two edges need to be carefully aligned to prevent puckering.



VELCRO FASTENINGS

Available for flat knit garments. The Velcro runs vertically down the length of the garment to oppose the two sides and close the garment.



SHOULDER CAP AND VELCRO BRA ATTACHMENT

Available for circular knit and flat knit garments.



SHOULDER CAP AND ADJUSTABLE STRAP

Available for circular knit and flat knit garments.

Grip tops



3cm and 5cm Strong Plain
Pertex Light, Pertex,
Goldpunkt, Star Cotton,
Doktus



3cm and 5cm Strong Plain
Venex



5cm Strong Lace



5cm Fine Lace



Lower Limb

Upper Limb

easywrap

Comfortwave

Midline

Essentials

Lymphitech

Lymphtech

Essentials

Midline

Comfiware

easywrap

Upper Limb

Lower Limb

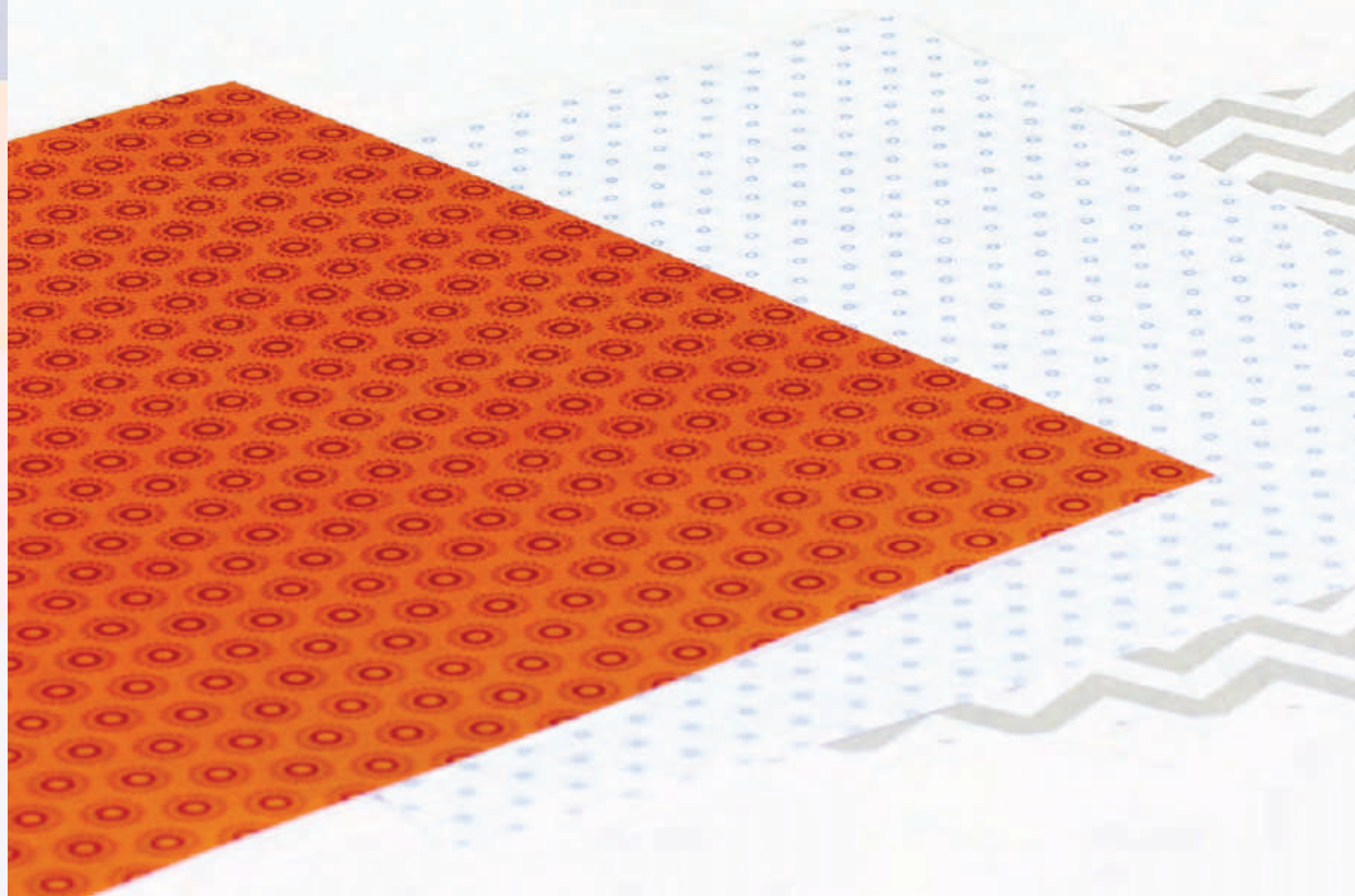



Freedom to choose

easywrap Compression made easy



easywrap Foot

Page 82 ▶



easywrap Leg

Page 84 ▶



easywrap Thigh

Page 86 ▶



easywrap Knee

Page 88 ▶



easywrap Arm

Page 90 ▶



easywrap Hand

Page 92 ▶



Additional Bands

Page 94 ▶



Custom Made

Page 96 ▶

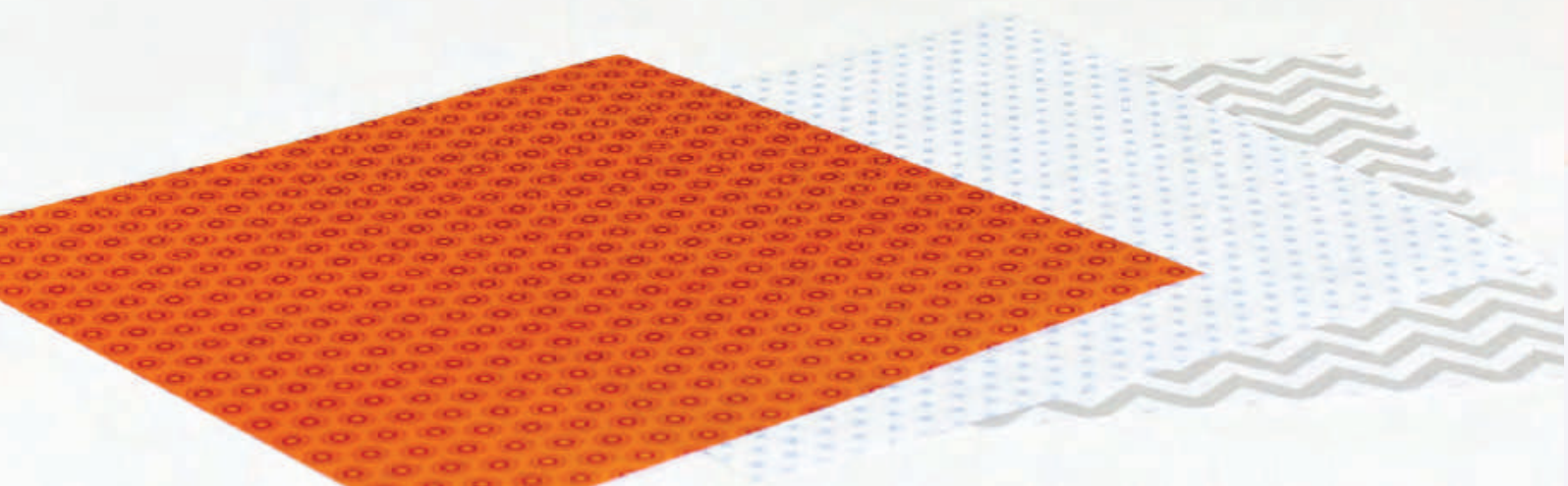



LOW PROFILE
 easywrap's low profile design means that it can be worn comfortably under most everyday clothing and footwear.

CHOICE OF TWO FABRICS

easywrap light is a more stretchy fabric suitable for mild to moderate compression needs.

easywrap strong provides similar stretch to a traditional short-stretch bandage, with excellent static stiffness performance.

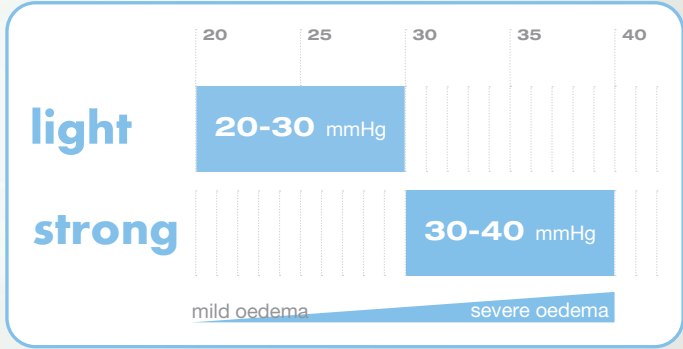

ADAPTS TO LIMB REDUCTION
 easywrap's UK patented technology provides all the benefits of classic short-stretch technology whilst the elastic in the bands maintains more consistent compression as the limb reduces.

SMART FASTENING

Easy-grab smart fasteners that only stick where they're supposed to.



TIME SAVING

A simple and effective alternative to bandaging and stockings. easywrap's unique weave ensures bands do not neck or kink making it easier to achieve a 50% overlap and consistent graduated compression.

EASY TO APPLY

Easy to feel "lock-out" or end-stretch makes them easy to apply at the correct tension so that you can be confident that you're getting the correct level of compression every time.



\$105

MODEL IS WEARING EASYWRAP FOOT
AND A - D LINER

easywrap[®] FOOT

Sizing

Circumferences cm

XS

S

M

L

XL

a¹ MID-FOOT

22-24

25-27

28-30

31-34

35-40

Length cm

REGULAR

14.5-16.5

16-18

17.5-19.5

19-21

21-23

a-heel

LONG

16.5-18.5

18-20

19.5-21.5

21-23

23-25

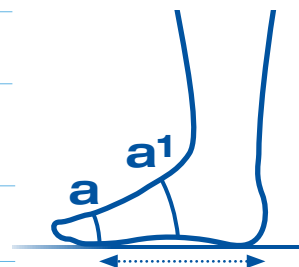

i See Page 96 for Custom Made details ▶

Light 20-30mmHg

STOCK items available in all sizes and both colours

COLOUR	LENGTH	XS	S	M	L	XL
 SAND	REGULAR	EL-FR1	EL-FR2	EL-FR3	EL-FR4	EL-FR5
	LONG	EL-FL1	EL-FL2	EL-FL3	EL-FL4	EL-FL5
 BLACK	REGULAR	ELB-FR1	ELB-FR2	ELB-FR3	ELB-FR4	ELB-FR5
	LONG	ELB-FL1	ELB-FL2	ELB-FL3	ELB-FL4	ELB-FL5



Strong 30-40mmHg

STOCK items available in all sizes and both colours

COLOUR	LENGTH	XS	S	M	L	XL
 SAND	REGULAR	ES-FR1	ES-FR2	ES-FR3	ES-FR4	ES-FR5
	LONG	ES-FL1	ES-FL2	ES-FL3	ES-FL4	ES-FL5
 BLACK	REGULAR	ESB-FR1	ESB-FR2	ESB-FR3	ESB-FR4	ESB-FR5
	LONG	ESB-FL1	ESB-FL2	ESB-FL3	ESB-FL4	ESB-FL5

easywrap Liners **STOCK**



LENGTH	COLOUR	XS / S / M	L / XL
A-d	 SAND	E-L-AD	E-L-ADW
	 BLACK	EB-L-AD	EB-L-ADW

PRICE: \$41.00 per pair, or **FREE** when ordered with an easywrap Foot together with an easywrap Leg.

\$165

MODEL IS WEARING EASYWRAP LEG WITH EASYWRAP FOOT AND A - D LINER

easywrap LEG

Sizing

Circumferences cm	XS	S	M	L	XL
c MID CALF	38-45	44-52	50-60	55-65	60-70
b ANKLE	23-27	28-32	33-38	39-44	45-52

Length cm	REGULAR	TALL
b-d ANKLE TO BELOW KNEE	30-34	34-38

i See Page 96 for Custom Made details ▶

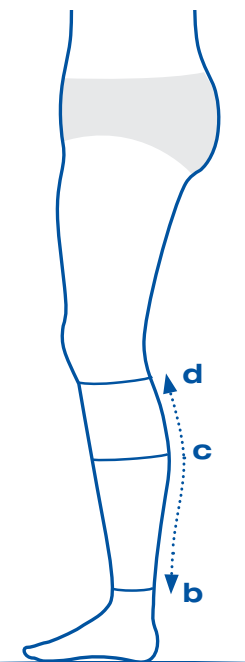

Our clinical team have developed a range of video guides to assist with measuring and donning easywrap
www.hadhealth.com.au/e-learning





Light 20-30mmHg

STOCK items available in all sizes and both colours

COLOUR	LENGTH	XS	S	M	L	XL
 SAND	REGULAR	EL-LR1	EL-LR2	EL-LR3	EL-LR4	EL-LR5
	TALL	EL-LT1	EL-LT2	EL-LT3	EL-LT4	EL-LT5
 BLACK	REGULAR	ELB-LR1	ELB-LR2	ELB-LR3	ELB-LR4	ELB-LR5
	TALL	ELB-LT1	ELB-LT2	ELB-LT3	ELB-LT4	ELB-LT5



Strong 30-40mmHg

STOCK items available in all sizes and both colours

COLOUR	LENGTH	XS	S	M	L	XL
 SAND	REGULAR	ES-LR1	ES-LR2	ES-LR3	ES-LR4	ES-LR5
	TALL	ES-LT1	ES-LT2	ES-LT3	ES-LT4	ES-LT5
 BLACK	REGULAR	ESB-LR1	ESB-LR2	ESB-LR3	ESB-LR4	ESB-LR5
	TALL	ESB-LT1	ESB-LT2	ESB-LT3	ESB-LT4	ESB-LT5

easywrap Liners **STOCK**



LENGTH	COLOUR	XS / S / M	L / XL
A-d	 SAND	E-L-AD	E-L-ADW
	 BLACK	EB-L-AD	EB-L-ADW

PRICE: \$41.00 per pair, or **FREE** when ordered with an easywrap Foot together with an easywrap Leg.

\$234



MODEL IS WEARING EASYWRAP THIGH WITH KNEE AND A - G LINER

easywrap[®] THIGH

WITH KNEE

Sizing

Circumferences cm	XS	S	M	L	XL
g TOP OF THIGH	60-70	65-75	70-80	75-90	85-100
e¹ BOTTOM OF THE THIGH	47-52	53-59	60-66	67-73	74-80

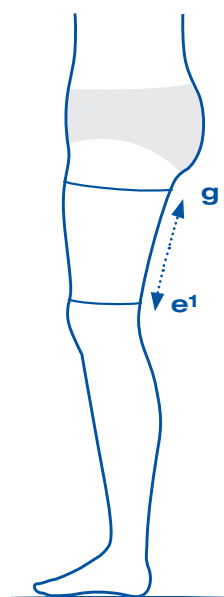

Length cm	SHORT	REGULAR	TALL
e¹-g BOTTOM OF THE THIGH TO TOP OF THIGH	16-20	20-24	25-30



i See Page 96 for **Custom Made** details ▶

Light 20-30mmHg

STOCK items available in all sizes and both colours

COLOUR	LENGTH	XS	S	M	L	XL
 SAND	SHORT	EL-TS1	EL-TS2	EL-TS3	EL-TS4	EL-TS5
	REGULAR	EL-TR1	EL-TR2	EL-TR3	EL-TR4	EL-TR5
	TALL	EL-TT1	EL-TT2	EL-TT3	EL-TT4	EL-TT5
 BLACK	SHORT	ELB-TS1	ELB-TS2	ELB-TS3	ELB-TS4	ELB-TS5
	REGULAR	ELB-TR1	ELB-TR2	ELB-TR3	ELB-TR4	ELB-TR5
	TALL	ELB-TT1	ELB-TT2	ELB-TT3	ELB-TT4	ELB-TT5



Strong 30-40mmHg

STOCK items available in all sizes and both colours

COLOUR	LENGTH	XS	S	M	L	XL
 SAND	SHORT	ES-TS1	ES-TS2	ES-TS3	ES-TS4	ES-TS5
	REGULAR	ES-TR1	ES-TR2	ES-TR3	ES-TR4	ES-TR5
	TALL	ES-TT1	ES-TT2	ES-TT3	ES-TT4	ES-TT5
 BLACK	SHORT	ESB-TS1	ESB-TS2	ESB-TS3	ESB-TS4	ESB-TS5
	REGULAR	ESB-TR1	ESB-TR2	ESB-TR3	ESB-TR4	ESB-TR5
	TALL	ESB-TT1	ESB-TT2	ESB-TT3	ESB-TT4	ESB-TT5

easywrap Liners STOCK



LENGTH	COLOUR	XS / S / M	L / XL
A-g	 SAND	E-L-AG	E-L-AGW
	 BLACK	EB-L-AG	EB-L-AGW

PRICE: \$51.00 per pair, or **FREE** when ordered with an easywrap Foot together with an easywrap Leg and easywrap Thigh.

\$134



Elliptical cut with spacer foam pad increases comfort and mobility whilst reducing pinching behind the knee.



MODEL IS WEARING EASYWRAP KNEE AND A - D LINER

easywrap[®] KNEE

Sizing

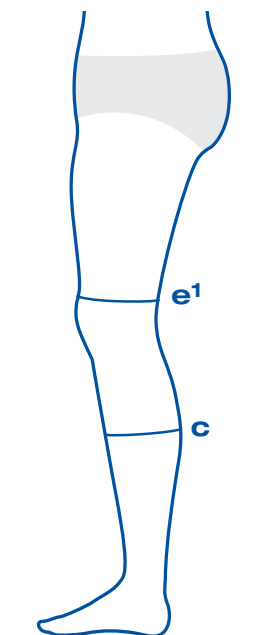

Circumferences cm	XS	S	M	L	XL
e¹ BOTTOM OF THE THIGH	47-52	53-59	60-66	67-73	74-80
c MID CALF	38-45	44-52	50-60	55-65	60-70

i See Page 96 for **Custom Made** details ▶





Light 20-30mmHg

STOCK items available in all sizes and both colours

COLOUR	XS	S	M	L	XL
 SAND	EL-KP1	EL-KP2	EL-KP3	EL-KP4	EL-KP5
 BLACK	ELB-KP1	ELB-KP2	ELB-KP3	ELB-KP4	ELB-KP5



Strong 30-40mmHg

STOCK items available in all sizes and both colours

COLOUR	XS	S	M	L	XL
 SAND	ES-KP1	ES-KP2	ES-KP3	ES-KP4	ES-KP5
 BLACK	ESB-KP1	ESB-KP2	ESB-KP3	ESB-KP4	ESB-KP5

easywrap Liners **STOCK**



LENGTH	COLOUR	XS / S / M	L / XL
A-g	 SAND	E-L-AG	E-L-AGW
	 BLACK	EB-L-AG	EB-L-AGW

PRICE: \$51.00 per pair, or **FREE** when ordered with an easywrap Foot together with an easywrap Leg and easywrap Thigh.

\$215



MODEL IS WEARING EASYWRAP ARM WITH EASYWRAP HAND

easywrap ARM

Sizing

Circumferences cm	S	M	L	XL
g AXILLA	22-31	29-39	32-45	36-50
e ELBOW CREASE	20-27	25-34	30-40	32-43
c WRIST CREASE	14-18	16-21	19-25	19-25

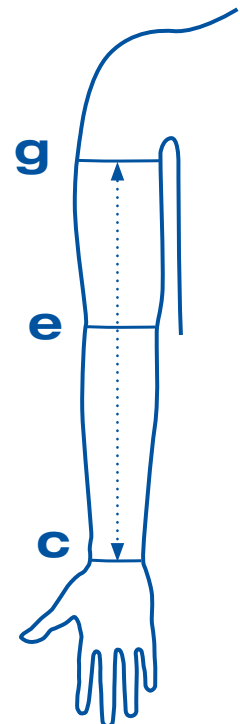

Length cm	SHORT	REGULAR	TALL
c-g WRIST TO AXILLA	40-44	44-48	48-52



i See Page 96 for Custom Made details ▶



Left 20-30mmHg

STOCK items available in all sizes, lengths and both colours

COLOUR	LENGTH	S	M	L	XL
 SAND	SHORT	EL-AS2L	EL-AS3L	EL-AS4L	EL-AS5L
	REGULAR	EL-AR2L	EL-AR3L	EL-AR4L	EL-AR5L
	LONG	EL-AL2L	EL-AL3L	EL-AL4L	EL-AL5L
 BLACK	SHORT	ELB-AS2L	ELB-AS3L	ELB-AS4L	ELB-AS5L
	REGULAR	ELB-AR2L	ELB-AR3L	ELB-AR4L	ELB-AR5L
	LONG	ELB-AL2L	ELB-AL3L	ELB-AL4L	ELB-AL5L

Right 20-30mmHg

STOCK items available in all sizes, lengths and both colours

COLOUR	LENGTH	S	M	L	XL
 SAND	SHORT	EL-AS2R	EL-AS3R	EL-AS4R	EL-AS5R
	REGULAR	EL-AR2R	EL-AR3R	EL-AR4R	EL-AR5R
	LONG	EL-AL2R	EL-AL3R	EL-AL4R	EL-AL5R
 BLACK	SHORT	ELB-AS2R	ELB-AS3R	ELB-AS4R	ELB-AS5R
	REGULAR	ELB-AR2R	ELB-AR3R	ELB-AR4R	ELB-AR5R
	LONG	ELB-AL2R	ELB-AL3R	ELB-AL4R	ELB-AL5R

\$85



MODEL IS WEARING EASYWRAP HAND

easywrap[®] HAND

Sizing

Circumferences cm	XS	S	M	L
b PALM LEVEL WITH THUMB WEB SPACE	<19	19-21	21-23	>24
a PALM AT BASE OF FINGERS	<18	18-20	20-22	>22

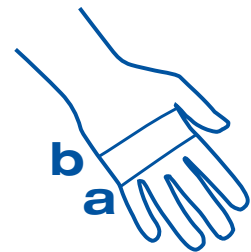

i See Page 96 for **Custom Made** details ▶

Left 20-30mmHg

STOCK items available in all sizes and both colours

COLOUR	XS	S	M	L
 SAND	EL-H1L	EL-H2L	EL-H3L	EL-H4L
 BLACK	ELB-H1L	ELB-H2L	ELB-H3L	ELB-H4L

Right 20-30mmHg

STOCK items available in all sizes and both colours

COLOUR	XS	S	M	L
 SAND	EL-H1R	EL-H2R	EL-H3R	EL-H4R
 BLACK	ELB-H1R	ELB-H2R	ELB-H3R	ELB-H4R

TIP

Consider adding a Microfine Glove to assist with the management of finger swelling and/or to provide additional compression for the dorsum of the hand (Page 70 Upper Limb Section)

easywrap®

ADDITIONAL BANDS

Available in
3 different
widths

A single band of easywrap lower limb material with hook and loop fasteners attached at either end. They can be used to provide additional support and compression to either the upper or lower limb.

Light 20-30mmHg

STOCK items available in all lengths and both colours

8cm

Length cm	20	25	30	35	40	45	50	55	60	150	200	
	\$39										\$78	
SAND	EL-0820	EL-0825	EL-0830	EL-0835	EL-0840	EL-0845	EL-0850	EL-0855	EL-0860	EL-08150	EL-08200	
BLACK	ELB-0820	ELB-0825	ELB-0830	ELB-0835	ELB-0840	ELB-0845	ELB-0850	ELB-0855	ELB-0860	ELB-08150	ELB-08200	

12cm

Length cm	45	50	55	60	65	70	75	80	150	200		
	\$69										\$138	
SAND	EL-1245	EL-1250	EL-1255	EL-1260	EL-1265	EL-1270	EL-1275	EL-1280	EL-12150	EL-12200		
BLACK	ELB-1245	ELB-1250	ELB-1255	ELB-1260	ELB-1265	ELB-1270	ELB-1275	ELB-1280	ELB-12150	ELB-12200		

16cm

Length cm	45	50	55	60	65	70	75	80	150	200		
	\$79										\$158	
SAND	EL-1645	EL-1650	EL-1655	EL-1660	EL-1665	EL-1670	EL-1675	EL-1680	EL-16150	EL-16200		
BLACK	ELB-1645	ELB-1650	ELB-1655	ELB-1660	ELB-1665	ELB-1670	ELB-1675	ELB-1680	ELB-16150	ELB-16200		

Strong 30-40mmHg

STOCK items available in all lengths and both colours

8cm

Length cm	20	25	30	35	40	45	50	55	60	150	200
	\$39									\$78	
SAND	ES-0820	ES-0825	ES-0830	ES-0835	ES-0840	ES-0845	ES-0850	ES-0855	ES-0860	ES-08150	ES-08200
BLACK	ESB-0820	ESB-0825	ESB-0830	ESB-0835	ESB-0840	ESB-0845	ESB-0850	ESB-0855	ESB-0860	ESB-08150	ESB-08200

12cm

Length cm	45	50	55	60	65	70	75	80	150	200
	\$69								\$138	
SAND	ES-1245	ES-1250	ES-1255	ES-1260	ES-1265	ES-1270	ES-1275	ES-1280	ES-12150	ES-12200
BLACK	ESB-1245	ESB-1250	ESB-1255	ESB-1260	ESB-1265	ESB-1270	ESB-1275	ESB-1280	ESB-12150	ESB-12200

16cm

Length cm	45	50	55	60	65	70	75	80	150	200
	\$79								\$158	
SAND	ES-1645	ES-1650	ES-1655	ES-1660	ES-1665	ES-1670	ES-1675	ES-1680	ES-16150	ES-16200
BLACK	ESB-1645	ESB-1650	ESB-1655	ESB-1660	ESB-1665	ESB-1670	ESB-1675	ESB-1680	ESB-16150	ESB-16200





easywrap[®]

Custom Made

These garments can be customised if measurements fall outside the stock range.



FOOT

LEG

THIGH

KNEE

ARM

HAND

Light 20-30mmHg

EL-FC

EL-LC

EL-TC

EL-KC

EL-AC

EL-HC

Strong 30-40mmHg

ES-FC

ES-LC

ES-TC

ES-KC

-

-

CUSTOM

\$170

\$285

\$165

\$239

\$366

\$139



Lower Limb

Upper Limb

easywrap

Confisure

Midline

Essentials

Lymphitech

Lymphhtech

Essentials

Midline

Comfiwave

easywrap

Upper Limb

Lower Limb





Freedom to choose

Comfiwave® Compression to drift off in



Below Knee

Page 102 ▶



Thigh

Page 103 ▶



Toecap

Page 104 ▶



Glove

Page 105 ▶



Glove to Axilla

Page 107 ▶



Sleeve

Page 108 ▶

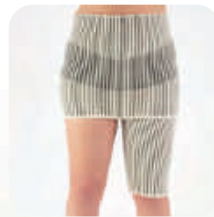

Abdominal

Page 110 ▶



Breast Band

Page 112 ▶



Lower Limb

Upper Limb

easywrap

Comfiwave

Midline

Essentials

Lymphtech

Comfiwave[®]



For night time

Oedema related swelling doesn't stop overnight but traditional compression garments are not best suited to being worn in bed. Continue compression therapy overnight in supreme comfort with Comfiwave's soft and breathable fabric providing gentle compression (15-21mmHg) while you sleep.

For any time

Comfiwave garments use proprietary 'low-resistance' yarns which allow them to be easily donned and doffed. Perfect for relaxing during the day.

The breathability of the fabric means that Comfiwave is suitable for use all year round, being cooler to wear than conventional hosiery.



Comfy at night

Complements treatment a patient receives during waking hours



Gentle

Can be used in palliative care



Versatile

Can be worn in combination with other garments such as wraps and bras

Whole-garment knitting technology

Easy colour coded sizing system

e.g.  = Large, Long

Comfiwave's wave patterning mimics the pressure differential massage effect that is ordinarily found in cut-foam, chip-bag style garments.

Comfiwave lower limb garments utilise a stiffened and shaped ankle to prevent 'cutting in' of the anterior ankle

The lateral toe section has also been knitted to stretch more, which can prevent pressure sores on the outside of the toes.

Heel section helps prevent slippage



Easy to don and doff

Patented, high-elastic knit makes Comfiwave easy to put on and take off



Soft, undyed cotton

100% cotton against the skin and seamless design ensures maximum comfort



Breathable fabric

Comfiwave's wave patterning gives it high air permeability for coolness and stretch



Comfiwave® Below Knee

	SHORT	REGULAR	LONG
S	CW1-AD2S	CW1-AD2R	CW1-AD2L
M	CW1-AD3S	CW1-AD3R	CW1-AD3L
L	CW1-AD4S	CW1-AD4R	CW1-AD4L
XL	CW1-AD5S	CW1-AD5R	CW1-AD5L

STOCK \$205 each

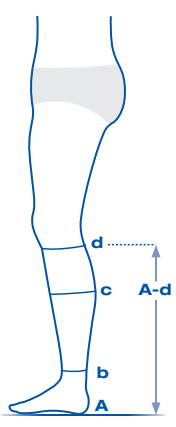

Circumferences cm	S	M	L	XL
c MID CALF	25 - 32	30 - 38	36 - 46	44 - 56
b ANKLE	17 - 22	20 - 26	22 - 30	27 - 35

Lengths cm	SHORT	REGULAR	LONG
A-d FLOOR TO 2 FINGER WIDTHS BELOW POPLITEAL CREASE	32 - 37	37 - 42	42 - 48



b
Ankle



c
Mid calf

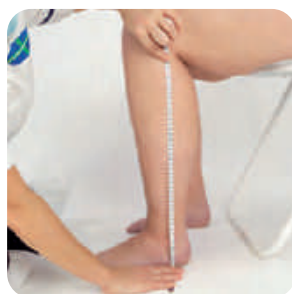

A-d
Floor to below knee



Comfiwave® Thigh High

	SHORT	REGULAR	LONG
S	CW1-AG2S	CW1-AG2R	CW1-AG2L
M	CW1-AG3S	CW1-AG3R	CW1-AG3L
L	CW1-AG4S	CW1-AG4R	CW1-AG4L
XL	CW1-AG5S	CW1-AG5R	CW1-AG5L
XXL	CW1-AG6S	CW1-AG6R	CW1-AG6L

STOCK \$310 each

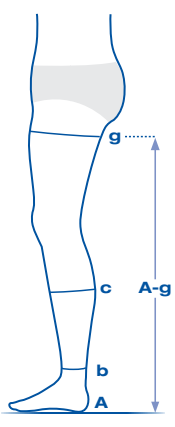

Circumferences cm	S	M	L	XL	XXL
g UPPER THIGH	40 - 48	46 - 56	54 - 65	62 - 75	72 - 92
c MID CALF	25 - 32	30 - 38	36 - 46	44 - 56	52 - 64
b ANKLE	17 - 22	20 - 26	22 - 30	27 - 35	27 - 35

Lengths cm	SHORT	REGULAR	LONG
A-g FLOOR TO UPPER THIGH	64 - 70	70 - 77	77 - 84



g
Upper thigh



A-g
Floor to upper thigh

Comfiwave® Toecap

REGULAR

M	CW1-ZA3	⋮
L	CW1-ZA4	⋮

STOCK \$175 each



Circumference cm	M	L
a BALL OF FOOT	20 - 27	26 - 34



a
Ball of foot

Comfiwave® Glove

REGULAR

S	CW1-ZC2	■ ■ ■
M	CW1-ZC3	■ ■ ■
L	CW1-ZC4	■ ■ ■

STOCK \$230 each



Lower Limb

Upper Limb

easywrap

Comfiwave

Midline

Essentials

Lymphtech

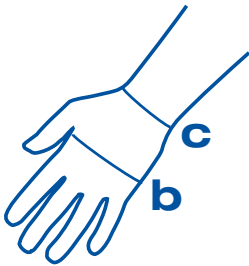

Circumferences cm	S	M	L
c WRIST	14 - 20	16 - 24	22 - 28
b PALM LEVEL WITH THUMB WEB SPACE	17 - 22	20 - 25	23 - 28



b
Palm level with thumb web space



c
Wrist

Comfiwave® Glove to Elbow

REGULAR

S	CW1-ZE2	⋮
M	CW1-ZE3	⋮
L	CW1-ZE4	⋮

STOCK	\$290 each
-------	------------

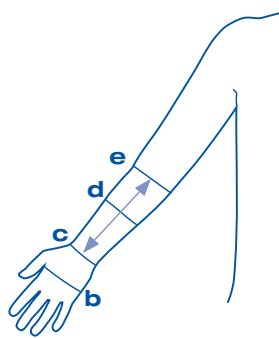

Circumferences cm	S	M	L
d MID-POINT OF FOREARM	23 - 28	26 - 32	30 - 38
c WRIST	14 - 20	16 - 24	22 - 28
b PALM LEVEL WITH THUMB WEB SPACE	17 - 22	20 - 25	23 - 28

Length cm	REGULAR
c-e WRIST TO ELBOW	20 - 24



b
Palm level with thumb web space



c
Wrist



d
Mid-point of forearm



c-e
Wrist to elbow



Comfiwave® Glove to Axilla

	SHORT	REGULAR
S	CW1-ZH2S	CW1-ZH2R
M	CW1-ZH3S	CW1-ZH3R
L	CW1-ZH4S	CW1-ZH4R

STOCK \$490 each

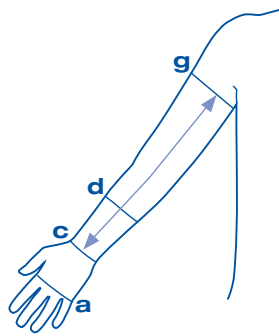

Circumferences cm		S	M	L
g	AXILLA	25 - 30	30 - 40	40 - 50
d	MID-POINT OF FOREARM	23 - 26	26 - 30	30 - 38
c	WRIST	13 - 18	18 - 22	22 - 28
a	PALM AT BASE OF FINGERS	16 - 22	18 - 24	20 - 26

Length cm		SHORT	REGULAR
c-g	WRIST TO AXILLA	36 - 42	40 - 46



a
Palm at base of fingers



c
Wrist



d
Mid-point of forearm



g
Axilla



c-g
Wrist to axilla

Comfiwave[®] Sleeve

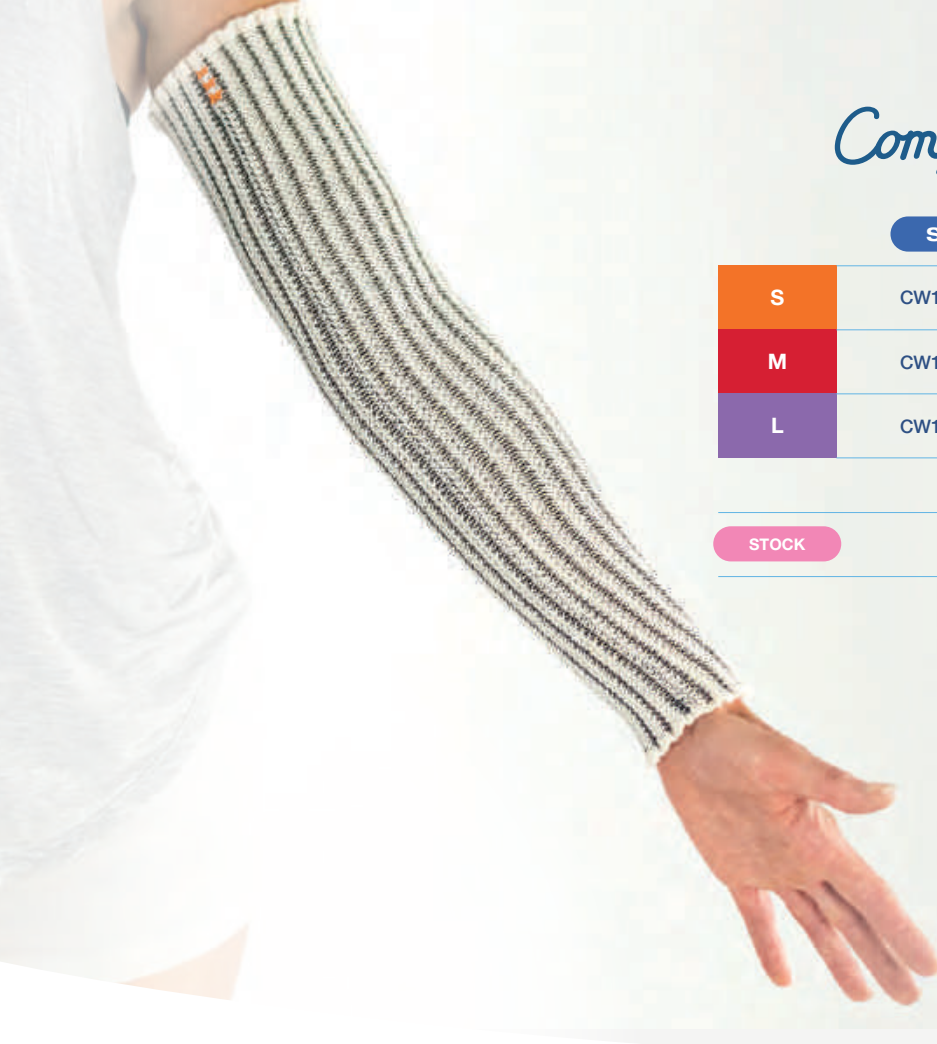

SHORT

REGULAR

S	CW1-CG2S	■	CW1-CG2R	■
M	CW1-CG3S	■	CW1-CG3R	■
L	CW1-CG4S	■	CW1-CG4R	■

STOCK \$158 each

Circumferences cm	S	M	L
g AXILLA	25 - 30	30 - 40	40 - 50
d MID-POINT OF FOREARM	23 - 26	26 - 30	30 - 38
c WRIST	13 - 18	18 - 22	22 - 28

Length cm	SHORT	REGULAR
c-g WRIST TO AXILLA	36 - 42	40 - 46

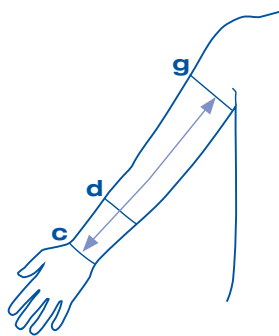

c
Wrist



d
Mid-point of forearm



g
Axilla



c-g
Wrist to axilla

Comfiwave® Sleeve + Mitten



Features elbow stretch zone for added comfort and ease of movement

	SHORT		REGULAR	
S	CW1-AH2S	■	CW1-AH2R	■
M	CW1-AH3S	■	CW1-AH3R	■
L	CW1-AH4S	■	CW1-AH4R	■

STOCK

\$263 each

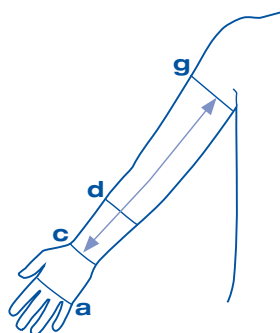

Circumferences cm	S	M	L
g AXILLA	25 - 30	30 - 40	40 - 50
d MID-POINT OF FOREARM	23 - 26	26 - 30	30 - 38
c WRIST	13 - 18	18 - 22	22 - 28
a PALM AT BASE OF FINGERS	16 - 22	18 - 24	20 - 26

Length cm	SHORT	REGULAR
c-g WRIST TO AXILLA	36 - 42	40 - 46

c-g
measurement
points shown on
Page 108



a
Palm at base of
fingers



Comfiwave® Abdominal Band

REGULAR

M	CW1-HT3	■ ■ ■
L	CW1-HT4	■ ■ ■
XL	CW1-HT5	■ ■ ■

STOCK \$265

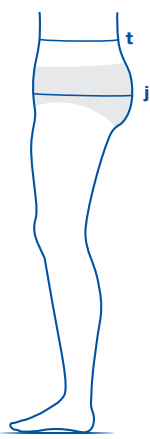

Circumferences cm	M	L	XL
t WAIST	60 - 70	70 - 85	90 - 120
j HIPS	80 - 90	90 - 105	110 - 140



j
Hips



t
Waist



Comfiwave[®] Thigh + Hip

	SHORT		REGULAR	
S	CW1-ET2S	■	CW1-ET2R	■
M	CW1-ET3S	■	CW1-ET3R	■
L	CW1-ET4S	■	CW1-ET4R	■
XL	CW1-ET5S	■	CW1-ET5R	■
STOCK		\$265		

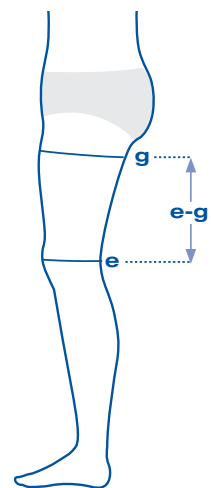

Circumferences cm	S	M	L	XL
g UPPER THIGH	40 - 48	46 - 56	54 - 65	62 - 75
e KNEE	27 - 35	33 - 39	41 - 50	48 - 60
Length cm	SHORT		REGULAR	
e-g KNEE TO UPPER THIGH	20 - 26		25 - 31	



g
Upper thigh

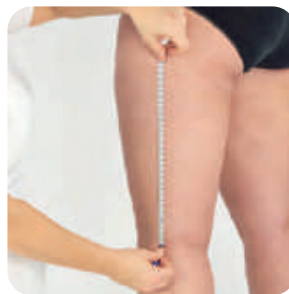

e-g
Knee to upper thigh

Comfiwave® Breast Band

REGULAR

S	CW1-TN2	■
M	CW1-TN3	■
L	CW1-TN4	■
XL	CW1-TN5	■

STOCK \$265

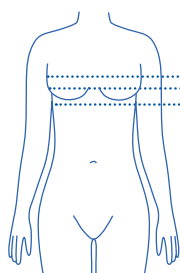

Circumferences cm	S	M	L	XL
ABOVE BREAST	70 - 88	80 - 102	90 - 116	100 - 130
OVER BREAST	70 - 92	80 - 108	90 - 126	100 - 144
BELOW BREAST	70 - 80	80 - 92	90 - 104	100 - 116



Above breast



Over breast



Under breast



Lower Limb

Upper Limb

easywrap

Confidare

Midline

Essentials

Lymphtech

Lower Limb

Upper Limb

easywrap

Comfluvare

Midline

Essentials

Lymphtech





Freedom to choose

Midline garments



Eto Bras

Page 116 ▶



Prairie Wear Bras

Page 118 ▶

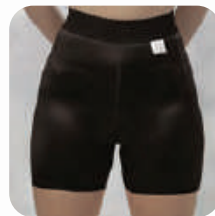

**Female Genital
Shorts**

Page 122 ▶



Head and Neck

Page 124 ▶



**Male Genital Shorts
and Pouches**

Page 126 ▶



Male Vests

Page 130 ▶

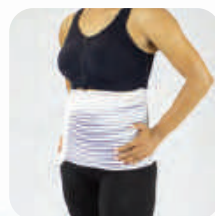

**Abdominal
Support**

Page 132 ▶

etogarments

Bras



ETOH601

V-neck bra with adjustable hook and eye fastenings and wide straps

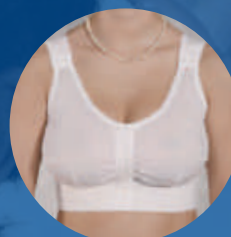

ETOH603

Scoop neck bra with adjustable hook and eye fastenings



ETOH603L

Longer body line extending to hips with adjustable hook and eye fastening

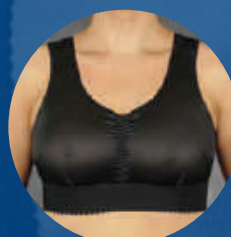

ETOH607

Scoop neck bra with simple sizing and no fastenings

1 Choose Style

	COMPRESSION	H601 COMPRESSION BRA	H603 COMPRESSION BRA	H603L COMPRESSION BRA	H607 COMPRESSION BRA
MTO	25-30 mmHg	ETOH601 from \$183	ETOH603 from \$183	ETOH603L from \$204	ETOH607 from \$150
CUSTOM	18-21 mmHg	ETOH601CM	ETOH603CM	ETOH603LCM	X
	23-32 mmHg	from \$291	from \$249	from \$289	

2 Choose Size

Circumferences cm	+\$19						
	XS	S	M	L	XL	XXL	XXXL
BRA SIZE	A	A / B	B / C	C / D	D / E	E / F	F / G
ABOVE BREAST	78-82	83-87	88-92	93-97	98-102	103-107	108-112
BELOW BREAST *	65-71	72-77	78-85	86-94	95-100	101-109	110-118
WAIST	60-65	66-72	73-79	80-90	91-98	99-106	107-113
HIPS H603L only	89-93	94-99	101-109	110-119	120-125	126-130	131-135

* Below breast measurement is the only measurement required for ETOH607

3 Choose Colour



WHITE



BEIGE



BLACK

Special Options

The below options are available for ETOH601, ETOH603 and ETOH603L only

	LOWER NECKLINE BY 4.5CM	VELCRO SHOULDER FASTENINGS	ZIP FRONT FASTENING	ADD PROSTHETIC POCKET	ADD EMPIRE FOAM For under breast support	ADD KLIMA COMFORT UNDER ARM GUSSET	WIDE/NARROW STRAPS 5cm / 8cm
MTO	ETOWLOW \$14	ETOVELCRO FREE	ETOSZIP \$26	ETOPOC \$25	ETOEMF \$35	ETOKUG \$35	ETOBBS \$12
CUSTOM	ETOWLOW \$14	ETOVELCRO FREE	ETOSZIP \$26	ETOPOC \$25	ETOEMF \$35	ETOKUG \$35	ETOBBS \$12



Ready to order?

Use **Custom Bra Form**

available at www.hadhealth.com.au/forms



PRAIRIE WEAR

Compression that Hugs [♥]



Hugger Bras

Comfortable support bras with 360-degree, wire-free mapped compression. For use in cases of Post-Surgery, Lymphoedema and everyday active wear.

- Full compression, coverage & security: compression that hugs the body
- Breast/Body pockets for custom compression & prosthetics.
- Just one measurement needed to find your fit.

Which Hugger is right for me? [♥]



	High impact activity & exercise	✓		✓
	Post-surgical & medical recovery	✓	✓	
	24/7 wear	✓	✓	
	Padded, adjustable shoulder straps	✓	✓	✓
	Adjustable band			✓
	Add an EXTENDER for versatility	✓	✓	
	Better for your body - certified skin safe	✓	✓	✓



HUGGERPRIMA

HIGH TO MEDIUM compression bra / binder

Operating Room Ready

Front zip with 2 G-hooks

Adjustable padded straps

Mapped 360° seamless knit and wire-free compression



Prima **EXTENDER**

Latex free, velcro free

Breast / Body pockets for custom compression, prosthetics & more



COMPRESSION

HUGGER PRIMA

PRIMA EXTENDER
(Bra Sizes S-M)

PRIMA EXTENDER
(Bra Sizes L-2XL)

MEDIUM - HIGH

HUG
\$122

EXT-M
\$49

EXT-L
\$49

1 Choose Size

Circumference cm

XS

S

M

L

XL

2XL

3XL

2XL + L Extender

ABOVE BREAST

66-71

76-81

86-91

96-102

107-112

117-122

127-132

2 Choose Colour

STOCK



PRAIRIE DAWN

STOCK



WHEAT BEIGE

STOCK



NO MOON BLACK

Between sizes?
For **PRIMA**, upsize.

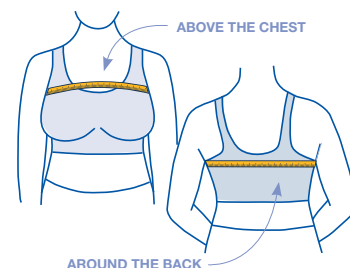

sales@hadhealth.com.au

119



HuggerVIDA

MEDIUM TO LOW compression bra

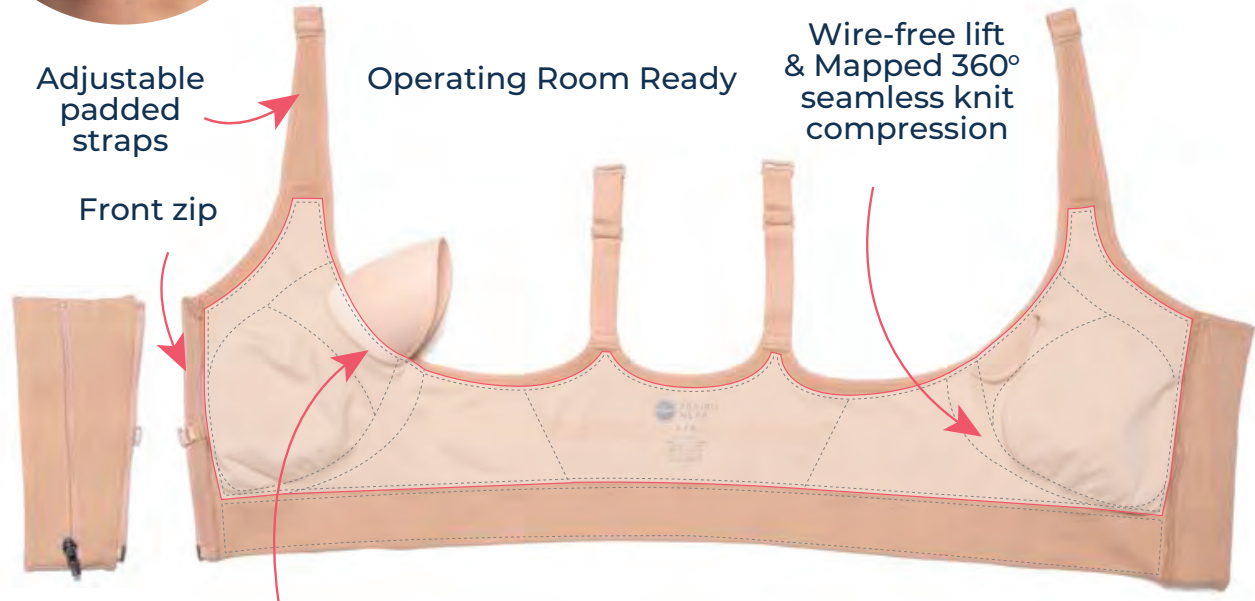

Vida **EXTENDER**

Breast / Body pockets for custom compression, prosthetics & more

Latex free, velcro free



COMPRESSION

HUGGER VIDA

VIDA EXTENDER
(Bra Sizes S-M)

VIDA EXTENDER
(Bra Sizes L-2XL)

LOW - MEDIUM

VIDA
\$126

VXT-M
\$49

VXT-L
\$49

1 Choose Size

Circumference cm

XS

S

M

L

XL

2XL

3XL

2XL + L Extender

ABOVE BUST

66-71

76-81

86-91

96-102

107-112

117-122

127-132

2 Choose Colour

VIDA EXTENDER only available in BEIGE and BLACK

STOCK



PRAIRIE DAWN

STOCK



WHEAT BEIGE

STOCK



NO MOON BLACK

Between sizes?
For **VIDA** downsize.

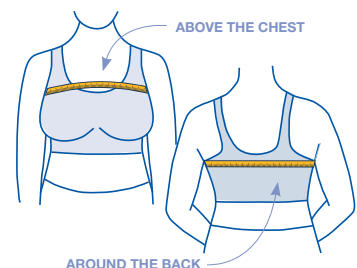

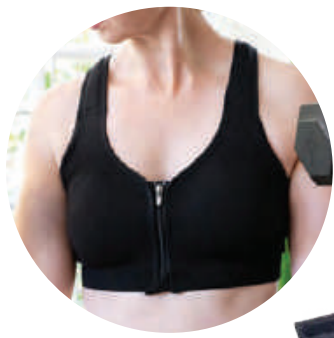

HuggerLUMA

HIGH TO MEDIUM compression sports bra

Moisture-wicking & wire-free

360° zoned compression



COMPRESSION	HUGGER LUMA
MEDIUM - HIGH	LUMA \$138

For **LUMA**:
Downsize if you're between sizes.
Upsize if you're a DD cup or higher.

1 Choose Size

Circumference cm	XS	S	M	L	XL	2XL
ABOVE BREAST	66-71	76-81	86-91	96-102	107-112	117-122

2 Choose Colour

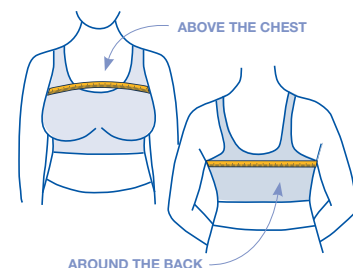

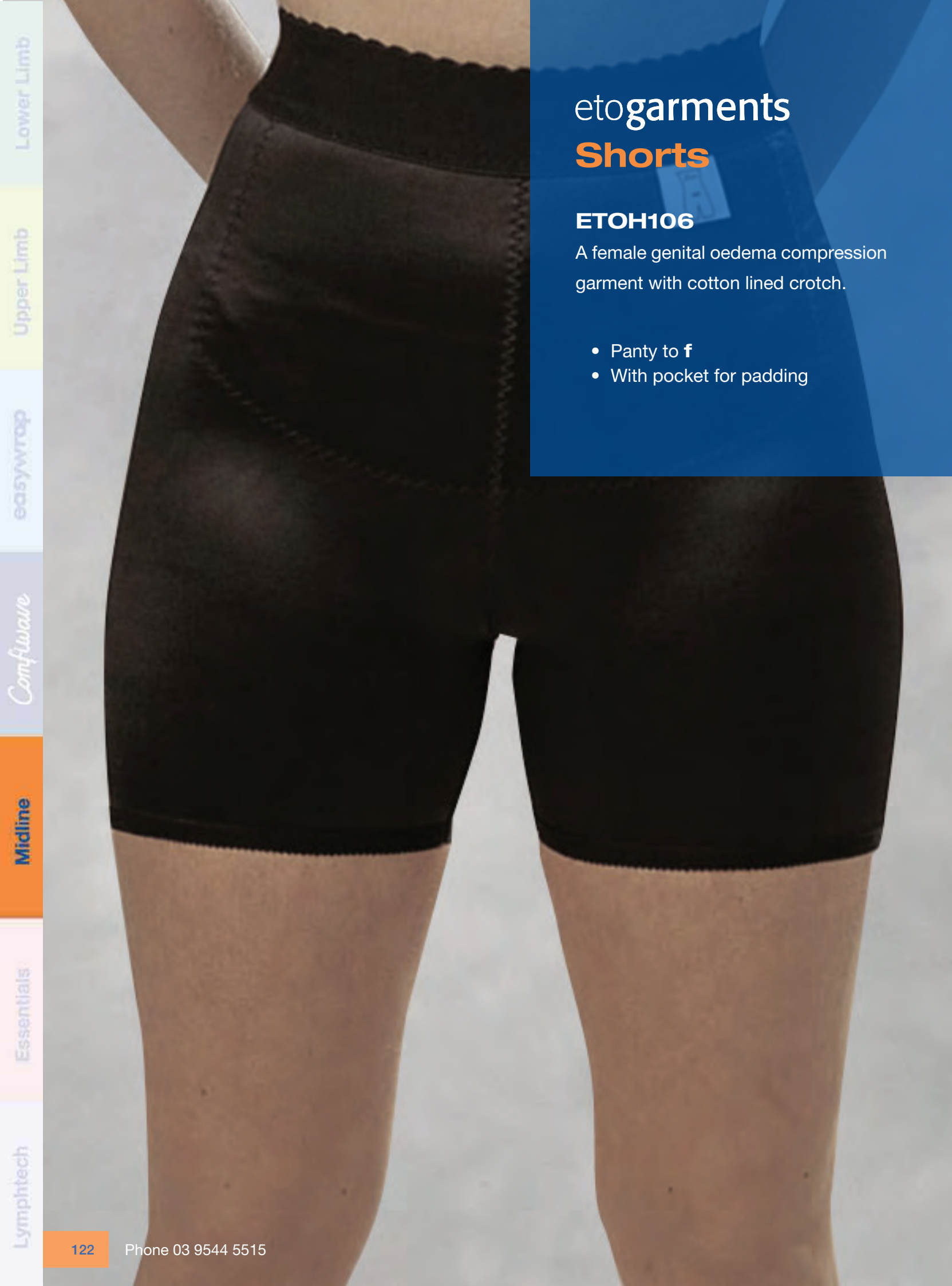

etogarments

Shorts

ETOH106

A female genital oedema compression garment with cotton lined crotch.

- Panty to **f**
- With pocket for padding

Lower Limb

Upper Limb

easywrap

Comfluare

Midline

Essentials

Lymphtech

1 Choose Style



H106
GENITAL COMPRESSION GARMENT

COMPRESSION

MTO

25-30 mmHg

ETOH106
from \$200

CUSTOM

25-30 mmHg

ETOH106CM
from \$291

2 Choose Size

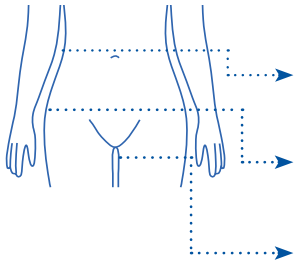

Circumferences cm

XS

S

M

L

XL

XXL

XXXL

WAIST

60-65

66-72

73-79

80-90

91-98

99-106

107-114

HIP

89-93

94-99

100-109

110-119

120-125

126-130

131-135

LEFT TOP

49-51

52-54

55-58

59-61

62-64

65-68

69-72

3 Choose Colour



WHITE



BEIGE



BLACK



Ready to order?

Use **Female Compression Shorts Form**
available at www.hadhealth.com.au/forms

etogarments

Head & Neck

ETO200 Series



- Custom Made available
- 25-30 mmHg



1 Choose Style

		COMPRESSION		
				
STOCK	25-30 mmHg	ETO201 \$95	ETO206 \$95	ETO209 \$105
MTO	25-30 mmHg	ETO201 \$95	ETO206 \$95	ETO209 \$105
CUSTOM	25-30 mmHg	ETO201CM from \$125	ETO206CM from \$125	ETO209CM from \$137

2 Size

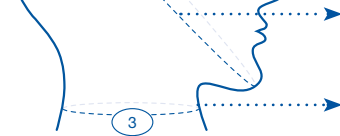
Circumferences cm	ETO201		ETO206		ETO209	
	STANDARD	XL	STANDARD	XL	STANDARD	XL
 ABOVE EYEBROWS	< 66	66 - 71	< 66	66 - 71	< 66	66 - 74
 POINT OF CHIN TO CROWN OF HEAD	< 66	66 - 71	< 66	66 - 71	< 66	66 - 74
 NECK	< 37	37 - 40	×	×	< 37	37 - 41

3 Choose Colour

ETO209 only available in Beige



WHITE



BEIGE



Ready to order?

Use **Head and Neck Form**
available at www.hadhealth.com.au/forms



etogarments

Male Genital

Male genital oedema compression garments with cotton lined crotch.



ETOH99
Male genital compression shorts



ETOH96
Male genital compression shorts with fly-opening

1 Choose Style



COMPRESSION

H99
GENITAL COMPRESSION GARMENT

H96
GENITAL COMPRESSION GARMENT
WITH FLY

MTO

25-30 mmHg

ETOH99
\$215

ETOH96
\$215

CUSTOM

25-30 mmHg

ETOH99
from \$287

ETOH96CM
from \$287

2 Choose Size

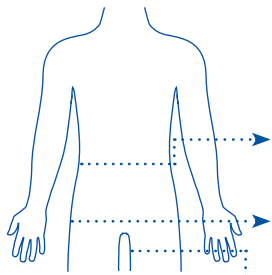

Circumferences cm

XS

S

M

L

XL

XXL

XXXL

WAIST

75-79

80-85

86-95

96-106

107-115

116-122

123-129

HIP

85-89

90-95

96-105

106-116

117-123

124-130

131-137

LEFT TOP

54-55.5

56-57.5

58-60

60.5-62

62.5-64

64.5-66

67-69.5

3 Choose Colour



BEIGE



BLACK



WHITE



Ready to order?

Use **Male Compression Shorts Form**
available at www.hadhealth.com.au/forms

Scrotal Pouches

1 Choose Style

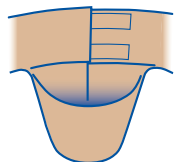

11
SCROTAL SUPPORT POUCH

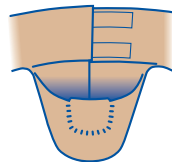

11P
SCROTAL SUPPORT POUCH WITH PAD



ETOBAND
WAIST BAND EXTENSION FOR ETO
POUCHES
specify length required

MTO

ETO11
\$130

ETO11P
\$140

ETOBAND
from \$30

CUSTOM

ETO11CM
from \$195

ETOH11PCM
from \$204

2 Choose Size

Circumference cm	S/M		L/XL		XXL	
	WAIST	90-105		106-119		120+

Circumference cm	1	2	3	4	5	6	7	8
	WIDEST POINT OF GENITALS	22-24	24-26	26-28	28-30	30-32	32-34	34-36

Length cm	S/M		L/XL		XXL	
	PUBIC BONE TO PERINEUM	23-26		26-29		29-32

3 Choose Colour

White and Black only available as **Custom Made**



BEIGE



BLACK

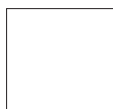

WHITE



Ready to order?

Use **Scrotal Support Garment Form**
available at www.hadhealth.com.au/forms



Haddenham Scrotal Support

Features

- No compression
- Off-white colour
- Adjustable Velcro® waist band



OFF-WHITE

1 Choose Style

	S	M	L	XL
STOCK	354-2 \$59	354-3 \$59	354-4 \$59	354-5 \$59
CUSTOM		GX-SC from \$85		

2 Choose Size

Circumferences cm	S	M	L	XL
WAIST	61-81	74-94	87-106	99-119

Abdominal Support Pouch

Soft cotton abdominal support pouch with adjustable Velcro® fastenings, available with extra padding.

	ABDOMINAL POUCH	WITH PADDING AROUND EDGE
CUSTOM	ETO12 PRICE BY QUOTATION	ETO12P PRICE BY QUOTATION

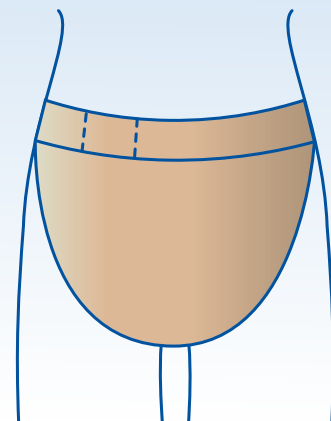

etogarments

Male Vests

Compression garments that provide support and compression in the chest and abdominal/truncal area.

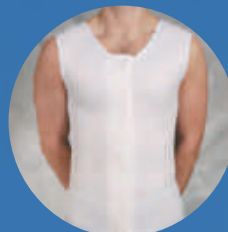

ETO400

Chest/Truncal compression vest with front zipper

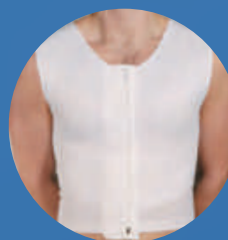

ETO402

Chest-only compression with front zipper

1 Choose Style



400
MALE COMPRESSION VEST



402
MALE COMPRESSION VEST

COMPRESSION

MTO

25-30 mmHg

ETO400
\$172

ETO402
\$172

CUSTOM

25-30 mmHg

ETO400CM
from \$248

ETO402CM
from \$248

2 Choose Size

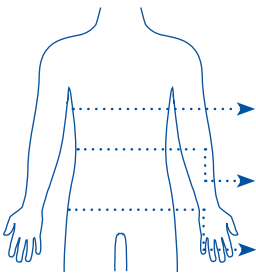

Circumferences cm

XS

S

M

L

XL

XXL

CHEST

79-83

84-89

90-99

100-110

111-120

121-125

WAIST

75-79

80-85

86-95

96-106

107-115

116-122

HIPS
400 only

85-89

90-95

96-105

106-116

117-123

124-130

3 Choose Colour



BEIGE



BLACK



WHITE



Ready to order?

Use **Male Vest Form**

available at www.hadhealth.com.au/forms

Haddenham Abdominal Wrap

A versatile wrap available in a large range of circumference sizes.

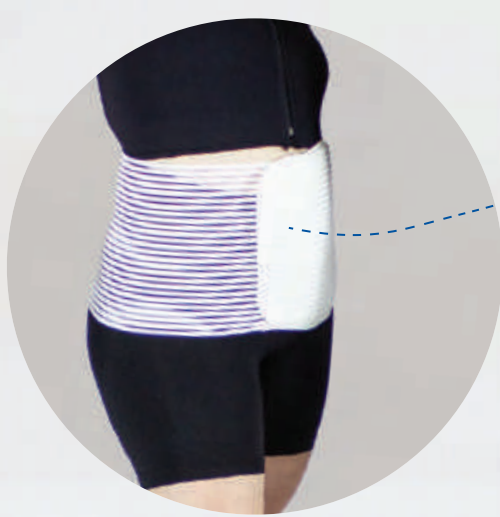

Large soft grip tab
Easy to apply and
adjust to fit



Machine washable

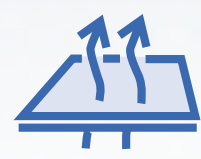

Air-permeable



Cotton against the skin

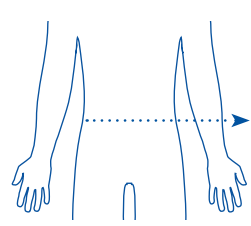

Circumference cm	1	2	3	4	5	6	7	8
WAIST	65-75	75-85	85-95	95-105	105-115	115-125	125-135	135-155
STOCK	12345 \$31	12346 \$31	12347 \$36	12348 \$36	12349 \$39	12350 \$39	12351 \$53	12352 \$64



Lower Limb

Upper Limb

easywrap

Confwave

Midline

Essentials

Lymphtech

Lymphhtech

Essentials

Midline

Comfluvare

easywrap

Upper Limb

Lower Limb





Freedom to choose

Essential Products for Lymphoedema



Kinesio Tape
Page 136 ▶



Foams & Padding
Page 138 ▶



Skin Care
Page 140 ▶



Donning Aids
Page 142 ▶



Extras
Page 145 ▶





K-Active®



The Original Kinesiology Tape

Kinesiology tape is used in clinics to help manage lymphoedema, particularly for areas of the body where compression is difficult to apply. Taping assists with lymphatic drainage by allowing lymph to move to an area which is less congested. Once in position, the tape gently lifts the skin, thereby helping the fluid to move into the deeper lymphatics.

- Premium quality
- Excellent skin compatibility
- Gentle variant for sensitive skin
- Economic purchase options for clinics
- From the original manufacturer in Japan



K-ACTIVE KINESIOLOGY TAPE STOCK

ORIGINAL - The original kinesiology tape.

ELITE - Suitable for moist or oily skin, and patients who are active during the day.

GENTLE - Suitable for children, elderly patients, and those with sensitive skin.

	ORIGINAL	ELITE	GENTLE
 BEIGE	KA-050	KAE-050	KAG-050
 BLACK	KA-050BL	x	x
 BLUE	KA-050B	x	x
 PINK	KA-050R	x	x
 GREEN	KA-050GR	x	x
1 ROLL 5cm x 5m	\$25.30 (inc GST)	\$27.50 (inc GST)	\$27.50 (inc GST)
MULTI-BUY OFFER BOX OF 6 ROLLS No other discounts apply	\$136.62 (inc GST)	\$148.50 (inc GST)	\$136.62 (inc GST)



NAQI CLEAN SKIN

Pre-taping spray, which improves the adhesion of kinesio tape. Skin-friendly cleanser.

	200ml
STOCK	
CODE	407
MULTI-BUY OFFER - 6 BOTTLES No other discounts apply	\$95.04 (inc GST)
SINGLE BOTTLE PRICE	\$17.60 (inc GST)

lymphpad



Foams and Padding

Haddenham Lymphpad, when used in conjunction with compression therapy, can help to break down fibrotic tissue by creating changes in tissue pressure which enhances the massaging effect of treatment. This in turn stimulates microcirculation, increases lymphatic drainage and assists with the removal of deposits. It can be used whole, trimmed to size, or joined together with medical adhesive tape to treat larger areas.

- Trims to fit
- Increases lymphatic drainage
- Helps break down fibrotic tissue

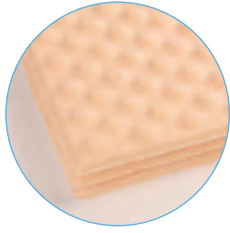

Foam: 100% Styrene-Butadiene
 Backing: 30% Polyamide;
 70% Polyester

LYMPHPAD DOT

STOCK

20.5cm x 29.5cm

CODE

LPD

PACK PRICE
 (Pack of 3)

\$93.50 (inc GST)

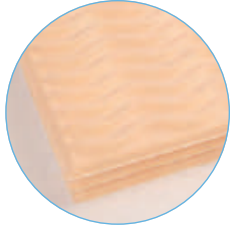

Foam: 100% Styrene-Butadiene
 Backing: 30% Polyamide;
 70% Polyester

LYMPHPAD WAVE

STOCK

20.5cm x 29.5cm

CODE

LPW

PACK PRICE
 (Pack of 3)

\$93.50 (inc GST)

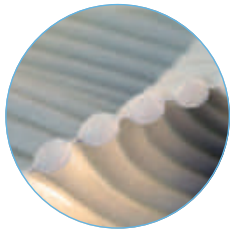

Foam: 100% Polyether
 Backing: 100% Polyester

SPAGHETTI FOAM

Large economical sheet that can be cut to size

STOCK

1.3m x 1m

CODE

87000

PRICE
 (Per sheet)

\$97.90 (inc GST)



SILICONE MALLEOLUS PADS

Soft silicone pads

STOCK

LEFT SIDE

RIGHT SIDE

CODES

425

426

PRICE

\$18.70 (inc GST)

\$18.70 (inc GST)



Skin Care

Lymphoedematous skin can be very dry, and small cracks may appear, causing leakage of clear fluid if not treated early. It is important to moisturise the skin daily to keep it soft and supple. By using non-perfumed creams and soap substitutes, the risk of skin irritation will be minimised.

- Reduces skin chafing
- Assists garment donning
- Hydrates and softens skin
- Helps maintain good skin condition



KLEBI SKIN ADHESIVE

Adhesive for maintaining the position of hosiery



"Nice consistency and easy to apply.
Holds my flat knit thigh high stocking in place all day."



"Very good. It works. Keeps below knee stockings in place all day until released."

STOCK

60ml

CODE

410

MULTI-BUY OFFER - 20 BOTTLES

No other discounts apply

\$297.00 (inc GST)

SINGLE BOTTLE PRICE

\$16.50 (inc GST)



CICA CREAM MOISTURISER

Formulated for use when wearing compression garments

STOCK

100ml

CODE

400

MULTI-BUY OFFER - 6 BOTTLES

No other discounts apply

\$213.84 (inc GST)

SINGLE BOTTLE PRICE

\$39.60 (inc GST)



NAQI BODY SCREEN MOISTURISER

Anti-friction formula for use when wearing compression garments.

STOCK

100ml

CODE

406

MULTI-BUY OFFER - 6 BOTTLES

No other discounts apply

\$225.72 (inc GST)

SINGLE BOTTLE PRICE

\$41.80 (inc GST)



Donning Aids and Accessories

Compression garments by their very nature are designed to provide a close fit. Haddenham provide a range of products that make application and removal easier.

- Increases compliance
- Restores independence
- Cuts donning and doffing time



steve+ On/Off CombiBox

Apply and remove compression stockings/sleeves independently in a few simple steps without bending down. Includes Steve+ Ring for removal.

	XS	S	M	L
CODES	ST1119822014	ST119822014	ST219822014	ST319822014
CALF CIRCUMFERENCE	25-30cm	30-38cm	38-46cm	46-54cm
STOCK	\$198.00 (inc GST)			



steve+ easyON

With Steve+ easyON you can easily put on all types of stockings - with or without assistance. Also works with armsleeves.

	XS	S	M	L
CODES	A1119822014	A119822014	A219822014	A319822014
CALF/UPPER-ARM CIRCUMFERENCE	25-30cm	30-38cm	38-46cm	46-54cm
STOCK	\$72.60 (inc GST)			



steve+ easyOFF Ring

Makes removing stockings and armsleeves easy.

	XS	S	M	L
CODES	R1119822014	R119822014	R219822014	R319822014
CALF/UPPER-ARM CIRCUMFERENCE	25-30cm	30-38cm	38-46cm	46-54cm
STOCK	\$58.30 (inc GST)			



steve+ Travel Bag

Bag for transporting Steve+ Donning/Doffing aids

	1 Bag
CODE	TB119822015
STOCK	\$20.90 (inc GST)



steve Glide Dolphin - Open Toe

Steve Glide is an easy and economical way of getting your compression socks on.

S

L

SGO119822014 SGO219822014

SHOE SIZE

4-9

10-13

STOCK

\$36



steve Glide Dolphin - Closed Toe

Steve Glide is an easy and economical way of getting your compression socks on.

ONE SIZE

SGC119822014

STOCK

\$36



steve Gloves

Maximum grip on your stockings. Machine washable at 30°C. Latex free.

S

M

L

XL

CODES

GN119822014

GN219822014

GN319822014

GN419822014

STOCK

\$9



steve Latex Gloves

Maximum grip on your stockings. Machine washable at 30°C. With Latex.

S

M

L

XL

CODES

GL119822014

GL219822014

GL319822014

GL419822014

STOCK

\$9

Fit Guide

Measure the width of your hand to determine the correct size for the Steve Gloves.

GLOVE SIZES -
HAND WIDTH

S

M

L

XL



7.5 - 8cm

8 - 8.5cm

9 - 9.5cm

10 - 10.5cm



GUS Basic Arm

Aid for application and removal of arm sleeves. Increases compliance and cuts down donning and doffing time.

M L

CODES

GUSBAM

GUSBAL

MID-FOREARM
CIRCUMFERENCE

< 30cm

31-36cm

STOCK

\$37

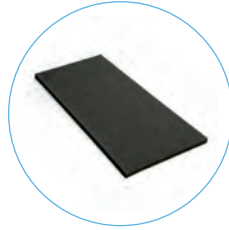

GUS Grip Mat

Anti-slip mat to aid in donning and doffing of hosiery and armsleeves.

20 x 38cm

CODE

HMCASM

STOCK

\$23.10 (inc GST)



HADDENHAM LTA BLUE ROUND BALL

1 Ball

CODE

440

STOCK

\$8.80 (inc GST)



THE BIG BOOK OF LYMPHOEDEMA

Introduces the condition and its treatment in a way that's easy to understand. Designed specifically for children.

1 Book

CODE

CB1

STOCK

\$22 (inc GST)

“

“I love my donning grip gloves. They make it so much easier to get my compression garment on.”

Tony

Feel Good

At Haddenham Healthcare, we appreciate that treating lymphoedema, lipoedema and chronic oedema is not just about prescribing compression garments. The daily habits and attitude of those with this condition make a considerable difference to how they feel and the possibility of stabilising or improving their health.

We have created resources to help your clients build positive habits and feel good. These are designed to support you to educate and motivate them towards the goal of self-efficacy. Refer to these resources as inspiration when educating and planning goals with your clients.

www.hadhealth.com.au/feel-good



Lower Limb

Upper Limb

easywrap

Comfortwave

Midline

Essentials

Lymphtech

Lymphtech

Essentials

Midline

Comfluvare

easywrap

Upper Limb

Lower Limb



LYMPHSCANNER

The LymphScanner is a non-invasive hand-held device capable of measuring localized percentage water content (PWC) in the early stages of lymphoedema. The percent water content (PWC) is a practical unit for clinical use, based on the measured tissue dielectric constant (TDC). The device may be used in the detection of preclinical lymphoedema through to advanced lymphoedema.

Measurement results are displayed in seconds after applying the measurement probe on the skin surface. A force sensor facilitates correct pressure and measures may be displayed at a spot or in scanning mode.

Easy and quick scanning of upper and lower limbs, as well as in areas of lymphoedema helps to detect regional distribution of lymphoedema in areas previously difficult to measure such as breast, head and neck region, thorax and genital region.

Our clinical team have developed a range of assessment forms to help guide your record keeping
www.hadhealth.com.au/lymphscanner



Benefits

Sensitive measurement for early detection of fluid accumulation

Rapid spot and scan measurements at any site

Force-monitored non-invasive probe touching the skin

Extremely practical one-button operation

Fully portable with rechargeable battery



Lymphoedema assessment

Measurement of PWC using the LymphScanner can be by spot or scan mode. The spot measure shows the PWC at a single skin site.

When measuring in scan mode, the ratio of the PWC at two measuring sites is displayed. This is to assess site to site differences, such as affected compared with unaffected sides. The LymphScanner displays the PWC of an initial reference site and calculates the ratio of any subsequent reading with respect to the PWC of the selected reference site. Although the PWC values vary by measurement site, age, BMI and gender, the ratio method, using the scanning mode, eliminates variations between individuals.

Check tool included

Easy-to-use device for checking the long term stability of the LymphScanner. It is recommended to use this once a month to assess the accuracy of the LymphScanner reading compared to the reference value set at the factory.

Training

Training is available on using the LymphScanner. Please contact us for more information.

Software

Additional software can be purchased for data transfer and storage of spot measurements by wireless PC connection.

LymphScanner

SINGLE

CODE

MDL2001

STOCK

Please request a quote from Customer Service

Service

SERVICE

CODE

MDL SERVICE

PRICE

Please request a quote from Customer Service

NOTE A LymphScanner calibration certificate is valid for 2 years.



Live Well



Live Well is a delivery model for Haddenham Healthcare wellbeing initiatives. This provides an opportunity to focus on how we feel and choosing to act in ways that take care of each other and ourselves. It is expressed through five elements that underpin a culture of health and wellbeing: connect, be active, keep learning, help others and be aware.



Putting wellbeing at the heart of business

ISSUE 7

Prices effective from August 2023

Haddenham Healthcare

Unit 6, 3 - 4 Anzed Court
Mulgrave Victoria 3170
AUSTRALIA

Customer Service

Support with orders, quotes, delivery and
exchanges. sales@hadhealth.com.au
PH: +61 3 9544 5515
Fax: +61 3 9544 5512

Clinical Advisors

For guided clinical reasoning to support your
choice of compression therapy
www.hadhealth.com.au/bookings
clinical@hadhealth.com.au

Resources

Assistance with Haddenham Healthcare product
literature and swatches
www.hadhealth.com.au